

YL-I-445 1~40W

### DIODE LASER AT 445nm

Diode laser 445nm is made features of ultra compact, long lifetime, low cost and easy operating. It's easy to be installed in customer's equipment.



### SPECIFICATIONS

Wavelength (nm)	445±5
Operating mode	CW
Output power (W) @ after 400um fiber	1~40
Fiber Core Diameter (um)	100, 200, 400, 600
Fiber Connector	SMA905/ FC
Numerical Aperture (NA)	0.22
Fiber length (m)	1 (Fiber length can be customized )
Power stability (rms, over 4 hours)	<1%
Cooled method	With TEC/ without TEC optional
Warm-up time (minutes)	<5
Operating temperature (°C)	25+/-3
Expected lifetime (hours)	10000
Warranty	1 year



### Dimensions of Laser head (Without TEC)

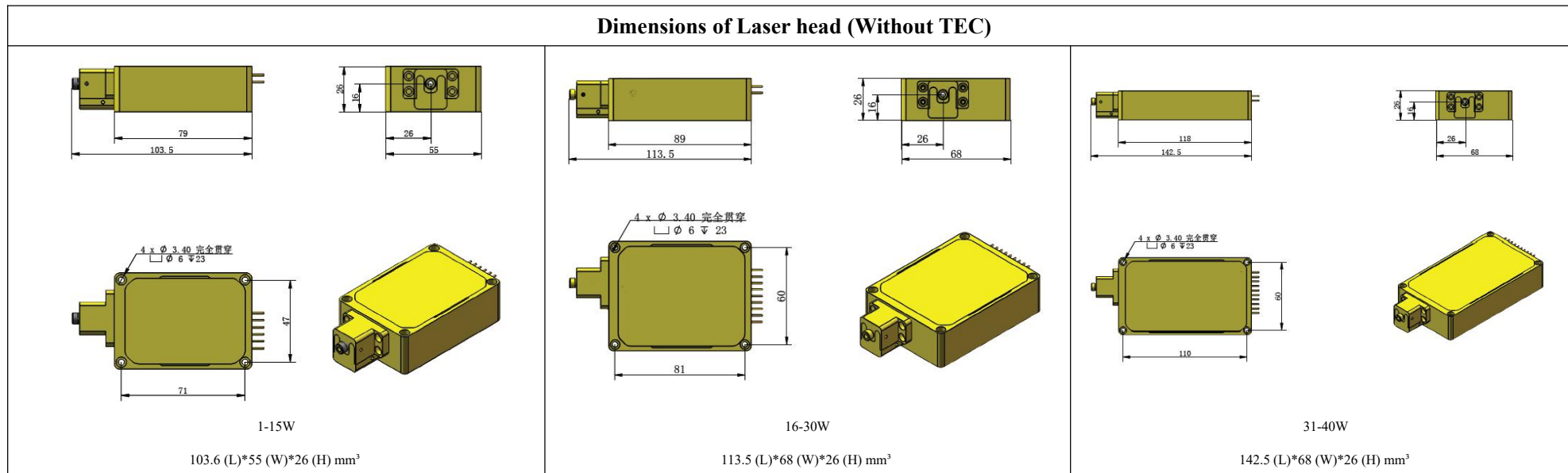

Dimensions of Laser head (With TEC)

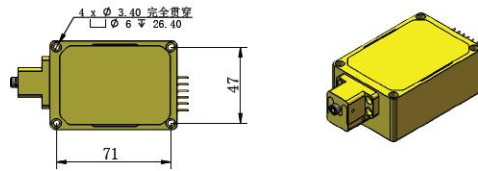

1-15W

103.6 (L)\*55 (W)\*32 (H) mm<sup>3</sup>

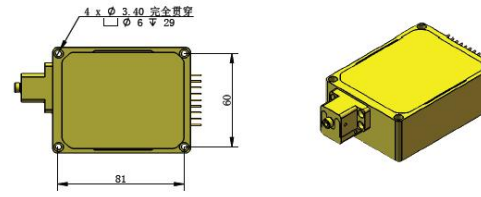
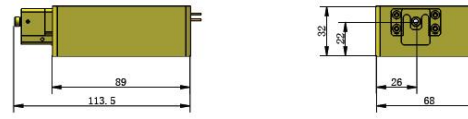

16-30W

113.5 (L)\*68 (W)\*32 (H) mm<sup>3</sup>

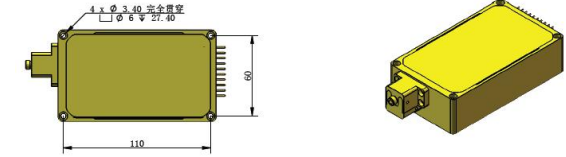

31-40W

142.5 (L)\*68 (W)\*32 (H) mm<sup>3</sup>