

## NAC2003-Hxx

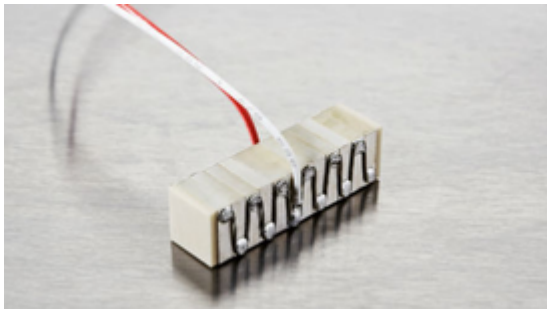

Noliac plate stack actuator NAC2003-Hxx (height in mm – Hxx) is based on the multilayer actuator NAC2003 and can be stacked to match your requirements. The standard range of NAC2003-Hxx is produced in a height between 4-50 mm. The plate stack provides a stroke up to 72  $\mu\text{m}$  and blocking force up to 1050 N depending on the height of the stack.

### SPECIFICATIONS

Attributes	Value	Tolerance
Length / outer diameter	5 mm	+0.30/-0.10 mm
Width / inner diameter	5 mm	+0.30/-0.10 mm
Max width / outer diameter max	6.8 mm	
Height	4 — 50 mm	+/-0.2 mm or 1% (whichever is largest)
Operating voltage, max.	60 V	
Free stroke, max.	3 — 72 $\mu\text{m}$	+/- 15%
Blocking force, max.	1050 N	+/-20%
Capacitance	1020-24625 nF	+/- 15%
Stiffness	350-15 N/ $\mu\text{m}$	+/-20%
Maximum operating temperature	150 °C	
Material	NCE51	
Unloaded resonance frequency	>248 k - 22 k Hz	
Electrodes	Screen-printed Ag and soldered bus wire (option: glued connections)	

### Stack options

Height	Stroke	Capacitance
4 mm	3 $\mu\text{m}$	1030 nF
6 mm	6 $\mu\text{m}$	2050 nF
8 mm	9 $\mu\text{m}$	3080 nF
10 mm	12 $\mu\text{m}$	4100 nF

12 mm	15 $\mu\text{m}$	5130 nF
14 mm	18 $\mu\text{m}$	6160 nF
16 mm	21 $\mu\text{m}$	7180 nF
18 mm	24 $\mu\text{m}$	8210 nF
20 mm	27 $\mu\text{m}$	9230 nF
22 mm	30 $\mu\text{m}$	10260 nF
24 mm	33 $\mu\text{m}$	11290 nF
26 mm	36 $\mu\text{m}$	12310 nF
28 mm	39 $\mu\text{m}$	13340 nF
30 mm	42 $\mu\text{m}$	14360 nF
32 mm	45 $\mu\text{m}$	15390 nF
34 mm	48 $\mu\text{m}$	16420 nF
36 mm	51 $\mu\text{m}$	17440 nF
38 mm	54 $\mu\text{m}$	18470 nF
40 mm	57 $\mu\text{m}$	19490 nF
42 mm	60 $\mu\text{m}$	20520 nF
44 mm	63 $\mu\text{m}$	21550 nF
46 mm	66 $\mu\text{m}$	22570 nF
48 mm	69 $\mu\text{m}$	23600 nF
50 mm	72 $\mu\text{m}$	24620 nF

# DRAWINGS

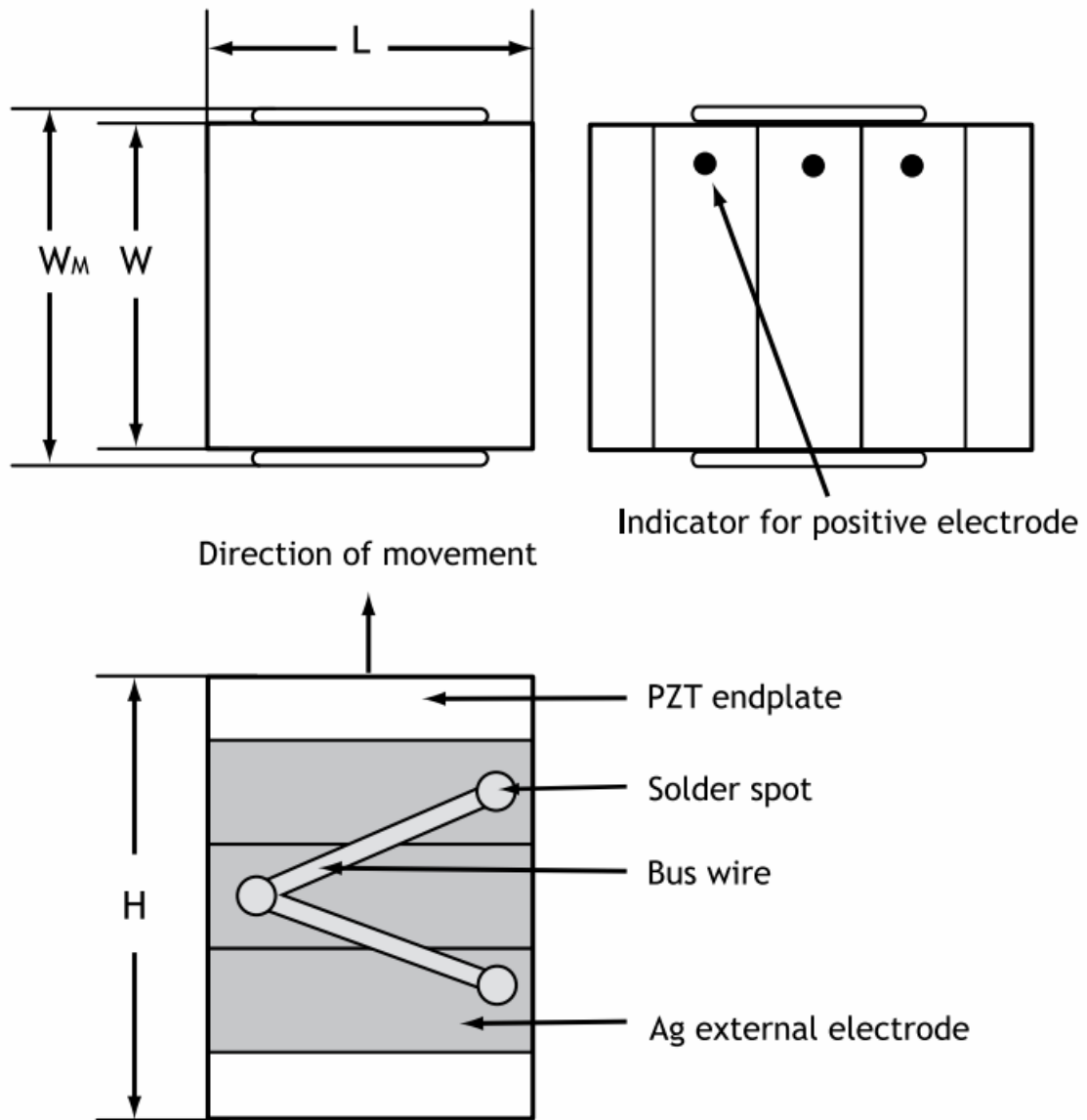

## MOUNT AND CONNECT

### Mounting

The actuators are usually grinded on top and bottom surfaces (perpendicular to the direction of expansion) in order to obtain flat and parallel surfaces for mounting. The actuators may be mounted either by mechanical clamping or gluing.

Avoiding short circuit can either be achieved by:

- Adding Kapton foil on the metallic surfaces.
- Having inactive ceramic plates between the actuator and the metal plate.
- Stacked actuators are manufactured with top and bottom insulating ceramic end-plates.

If glued, it is important to ensure a very thin glue line between the actuator and the substrate. It is recommended that a pressure, e.g. 2-5 MPa, is applied during the curing process.

To avoid significant loss of performance, the mounting of the actuators should avoid mechanical clamping and/or gluing on the sides of the actuator.

During manufacturing or handling, minor chips on the end-plates can appear. Minor chips cannot be avoided, but such chips do not affect performance.

### Electrical connection

External electrodes

The external electrodes are screen printed silver as standard. Other materials, e.g. gold or silver/palladium are available on request. The positive electrode is indicated by a black spot.

Electrical connection to the external electrodes can be achieved by mechanical contacts, soldering, gluing with electrically conductive glues or wire bonding.

Mechanical connections

Mechanical connections can be arranged by e.g. copper springs contacted to the external electrodes. It is recommended to use external electrodes of gold in order to eliminate oxidation of the electrodes.

## Soldering

Soldering electrical wires to the screen-printed silver electrode makes an excellent and time-stable connection. In order to avoid challenges with wetting the solder on the silver surface, always clean the external electrodes with a glass brush or steel wool.

The actuators may only be stressed axially. Tilting and shearing forces must be avoided.

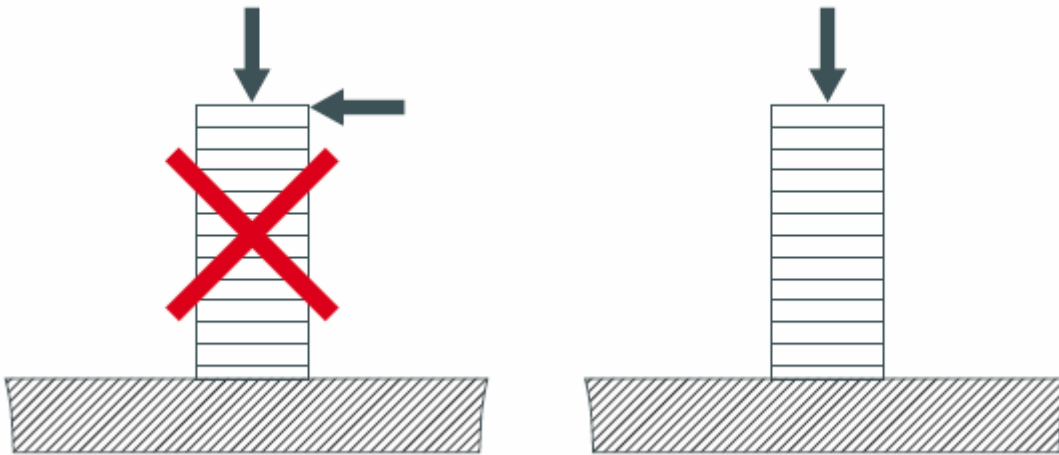

The actuators without preload are sensitive to pulling forces. It is recommended to apply a pre-load in order to optimize the performances of the actuators.

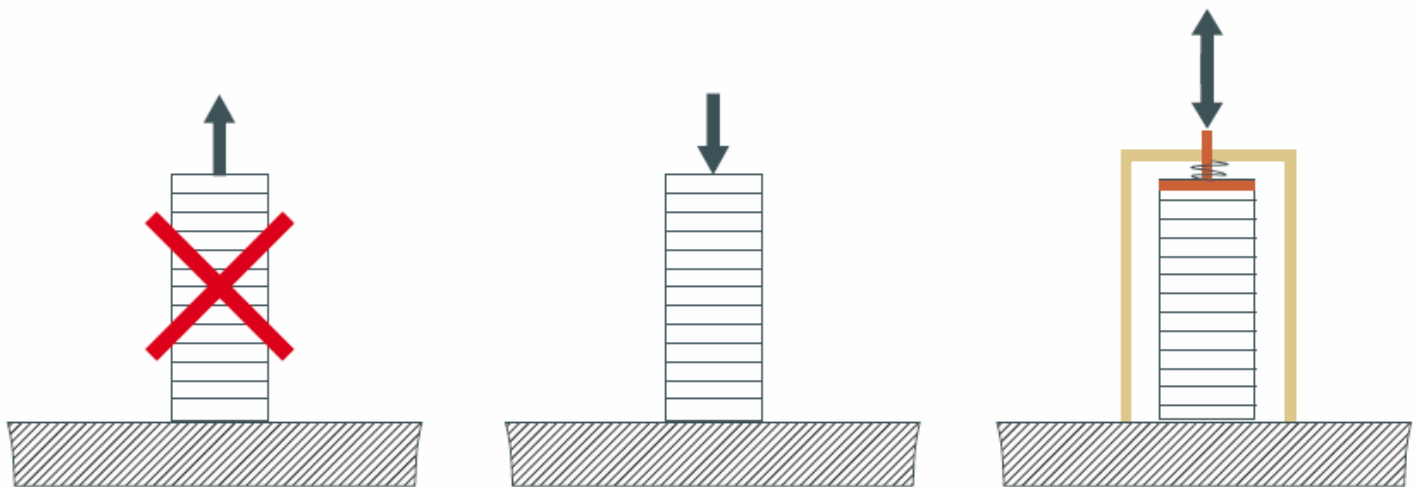

For linear actuators it is recommended not to use a metal plate on top and bottom in order to avoid short circuit.

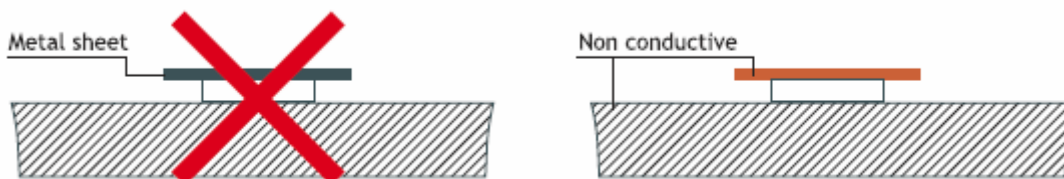

The force must be applied on the full surface of the actuator in order to assure a good load distribution.

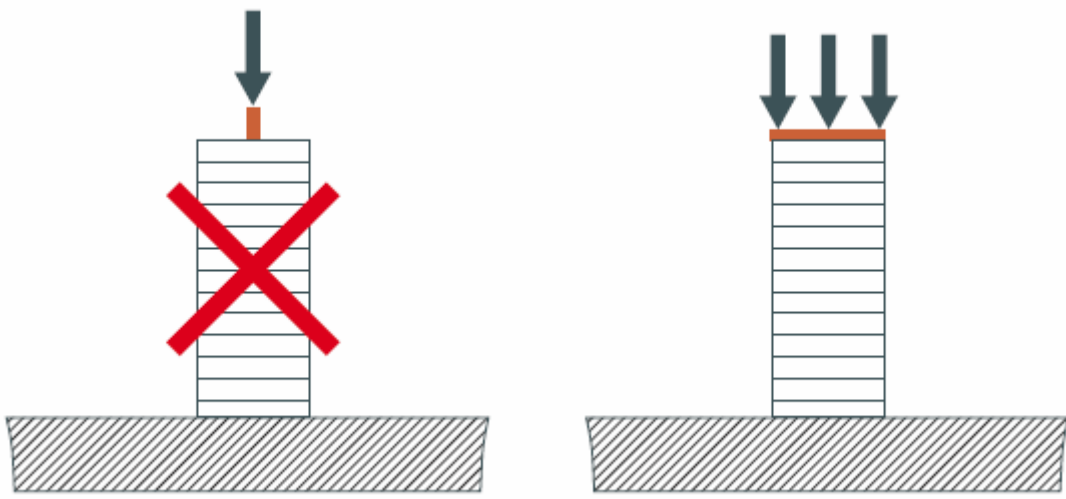

Epoxy glues are well suited for gluing piezoceramics.

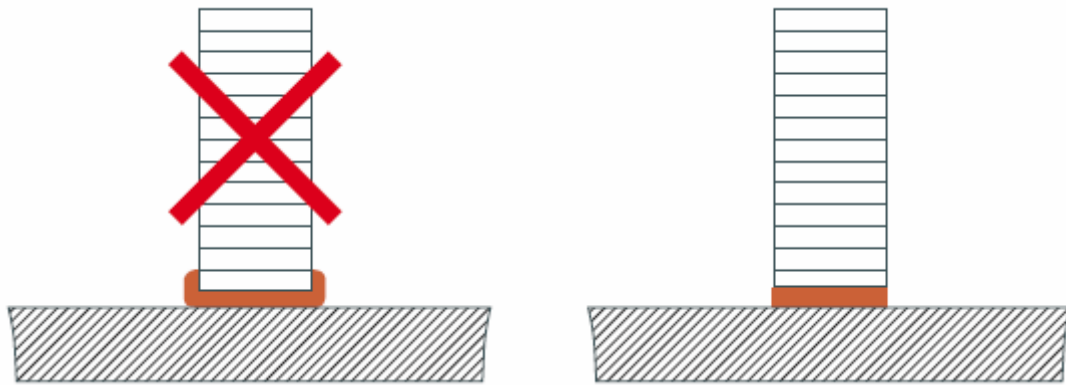

## WIRES

When you order actuators from Noliac, you can have wires fitted to save time and money. However, you should consider these parameters, when you select a wire for connection:

- Operation voltage
- Intensity of current
- Operating temperature
- Environment for example vacuum

### We recommend Teflon wires

Teflon wires can stand temperatures above 200 °C, whereas PVC wires only resist temperatures up to 80 °C. In tough operating conditions or in vacuum, it is recommended always to use Teflon isolated wire to guarantee the proper performance of PZT-elements.

### Wire thickness (AWG)

The wire thickness (AWG) is determined by the current that has to be transmitted to and from the PZT-element. The required current is determined by the capacitance of the PZT-element, the maximum driving frequency and the maximum voltage  $U_{p-p}$ .

	Option A01	Option A02	Option C
Type	28 AWG Teflon	28 AWG Teflon	Custom
Length	200 +/- 10mm	200 +/- 10mm	To be defined
Position	Middle of the actuator	Middle of the actuator	To be defined
Direction	Perpendicular to the height	Toward top	To be defined

## Type A01

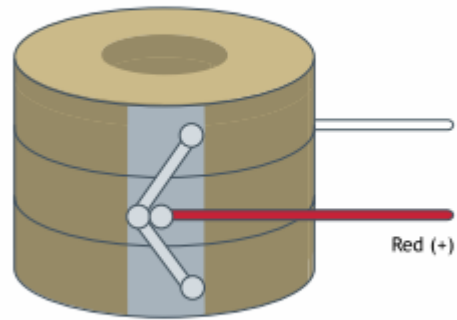
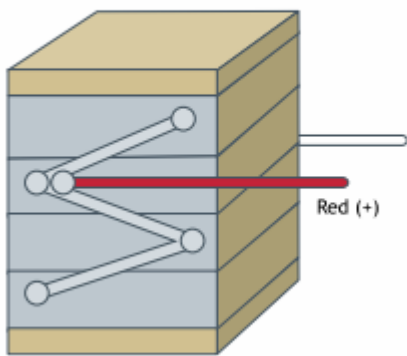

## Type A02

