

First Steps towards Piezoaction

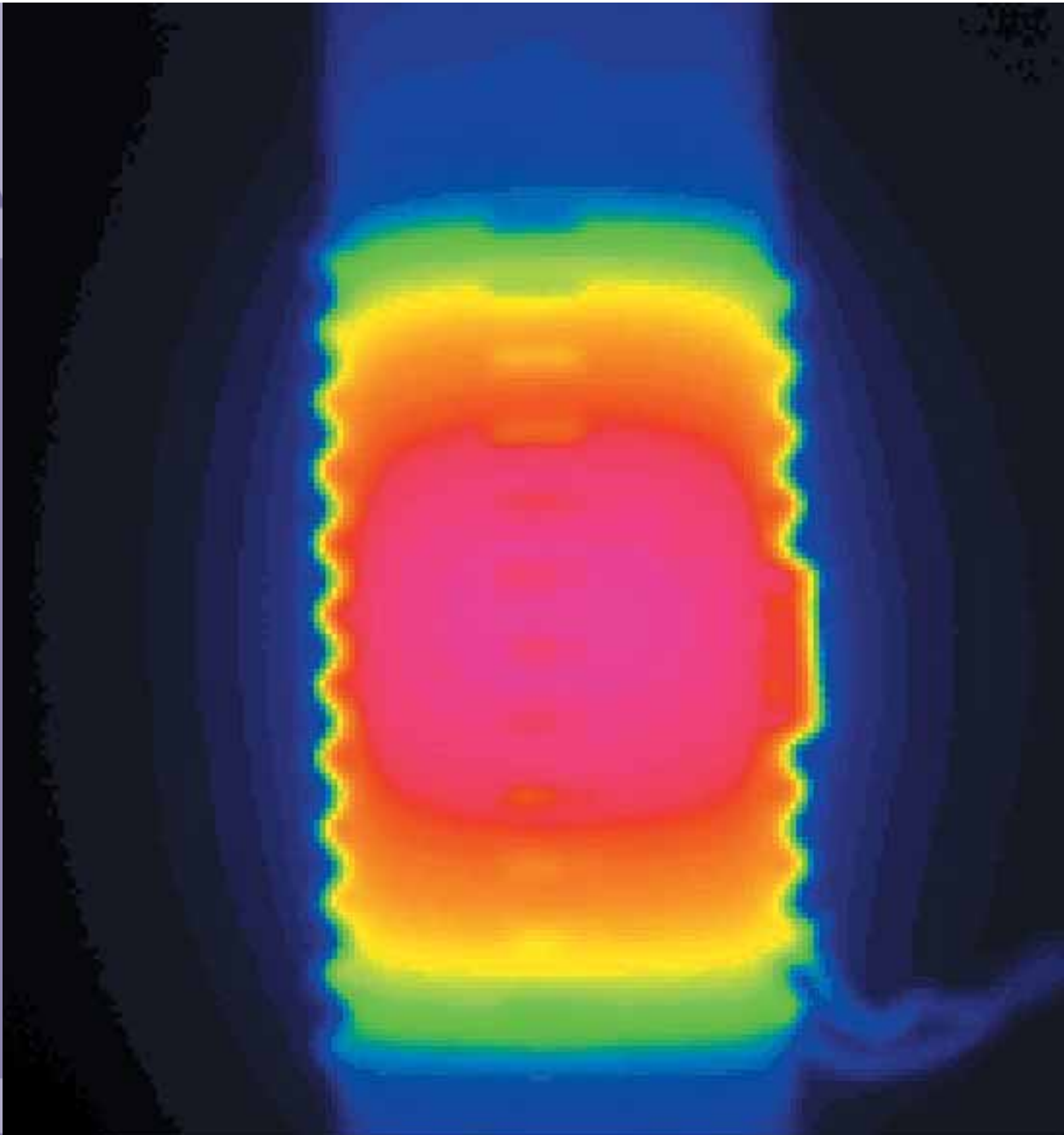

Thermograph of a dynamically operated piezo stack

The intention of this paper is to give newcomers to the field of “piezo-actuation” or “piezo-mechanics” a brief overview of the topic.

In discussing stack based piezo-actuators, many aspects reviewed can easily be applied to other piezo-actuation principles.

For more comprehensive studies, refer to the available specialized literature.



Contents

1.	■ Piezo stack actuators: A survey	7
1.1	Basic game rules	7
1.2	Characterizing piezo stack actuators Stroke (shift) - force balances - dynamics - performance limits	9
1.3	Actuator designs	11
2.	■ Basic stack designs	12
2.1	The piezo-mechanical effect	12
2.2	High Voltage versus Low Voltage: a comparison	12
2.3	Stack configurations	14
2.4	Ring stacks versus piezo tubes: a comparison	15
2.5	Ring stacks versus bulk stacks: a comparison	16
2.6	Advantages of PIEZOMECHANIK's piezo stacks	17
3.	■ Precision positioning	19
3.1	Shift versus voltage characteristic	19
3.2	Precision positioning by piezo stacks	21
3.3	Limits of positioning accuracy	22
4.	■ Motion and Forces	23
4.1	Beyond simple positioning	23
4.2	Examples for force/shift relations	24
4.3	Piezo-actuator as an active spring	25
4.4	Selecting a piezo stack	25
4.5	Force generation	27
4.6	Stiffness	29
4.7	Force limitations, load capabilities	31
4.8	Dynamic operation	31
4.9	Mechanical preloading (pre-stress)	32



Contents

5.	■ Dynamic operation of piezo stacks	35
5.1	Definitions	35
5.2	Short-term excitation	36
5.3	Long-term operation	37
5.4	Typical operating frequencies	38
5.5	Resonance	40
6.	■ Extended functionality, options	42
6.1	Heat management “Thermostable”	42
6.2	Temperature sensing	43
6.3	Low temperature operation	43
6.4	Position sensing	44
6.5	Further modifications Enhanced mechanical preload - Vacuum operation - Rotating systems - Non-magnetic configurations - Special materials	45
7.	■ Operation instructions	46
7.1	Basic comment on actuator reliability	46
7.2	First check of a piezo-actuator	47
7.3	Thumb rules	48
7.4	Handling and operation Mechanical aspects - Electrical aspects - Thermal aspects	49
7.5	Adhesives - Electrical contacts - Chemistry	54
7.6	Further aspects Environmental influences - Vacuum operation - Noble gases, hydrogen atmospheres - Radiation - Space-borne application	56
8.	■ Properties of piezoceramics	57
	Voltage versus Shift diagrams, hysteresis, Materials data, Temperature-related properties, Special ceramics (ultrasound ceramics, electrostriction)	



Contents

9.	■ Electrical powering of piezo-actuators	62
9.1	Electrical input and piezo-mechanical reaction Noise - Peak currents - Mean currents - Energy-/power-balances, energy dissipation - Electrostriction - Unipolar/semi-bipolar/bipolar operation	62
9.2	Alternatives: charge versus voltage control	66
9.3	Basic piezo amplifier functions	68
10.	■ Selecting a proper actuator	69
11.	■ New trends	70
11.1	Piezo action for material testing	70
11.2	Motion control	72
11.3	Electrical energy generation Force transducers - Energy harvesting, scavenging - Piezo transformers	73



Glossary

Actuator:

Mechanical actuator is synonym for motor, motion generator, mover; often used in context with linear displacements of limited range.

The term motor is commonly used for rotating drives with unlimited period of unidirectional action.

Smart material:

Special materials providing controllable features and properties beyond the classical behavior

Solid-state materials:

showing induced deformation: memory alloys, piezo-effect, magneto-striction

Liquids:

electro- and magneto-rheological systems with controllable viscosity

Solid-state actuator:

Based on all kinds of solid-state materials providing a controllable motion or force generation by material's internal structure or texture (prime mover effect)

Piezo-actuator:

Solid-state actuator, using the inverse piezo-electrical effect

Synonyms: piezo-translators, piezo-transducers

Piezo stack actuators:

Piezo stack actuators use the variation of the stack-length under electrical activation. This is in contrast to other kinds of moving profiles like shear elements or bending elements (bimorphs).

Piezo-mechanics:

Shorter expression than "inverse piezo-electric" describing the motor or actuator application of the piezo-effect (in contrast to the "piezo-electrical" generator effect).

Smart structures

Mechanical arrangements based on smart materials to control the mechanical properties of the arrangement e.g. by electrical means.

Adaptronics:

Wide cross over with "mechatronics" or "smart structures":

the science of mostly mechanical systems using "smart materials" together with a sophisticated electronics to get a kind of "learning process" and self-adaption for getting an optimum system's behavior.

Synonyms:

Actuator displacement = stroke = shift = expansion = elongation

Piezo stack actuators: A survey

1

1.1 Basic game rules

Piezo stack actuators are used as linear electromechanical drives or motors. They act mainly like an expanding element (“pusher”) generating a compressive force. The complete motion cycle is nearly proportional to the voltage signal input from DC up to high frequencies.

From an electrical point of view, piezo-actuators behave like electrical capacitors:
The induced motion can also be described as the consequence of the variation of the electrical charge content of the piezo-actuator.

Piezo-actuators are based on a special smart material: The electro-active piezoceramic material, known as PZT made of Pb (lead)-Zr (zirconium)-Ti (Titanium) mixed-oxides.

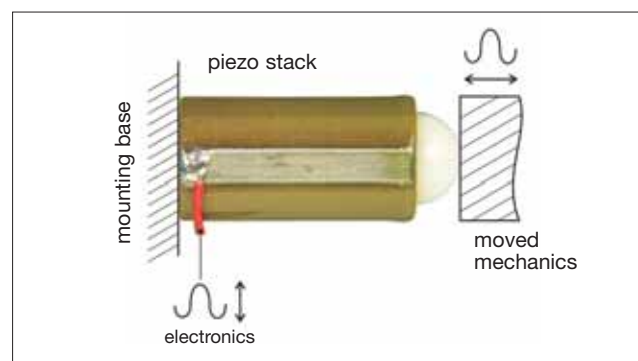

Fig. 1.1: Schematic of a piezo-mechanical system based on a piezo stack, mounted on a solid base, moving the attached mechanics by electrically induced strain of the stack.

The main characteristics of piezo motion are:

- Small shifts
- High force generation
- High mechanical load capability
- High stiffness (low compliance)
- High dynamics



1.1 Basic game rules

Decision guidance for using piezo-technology

- Verify that piezo-actuators will benefit your application in a way that alternative solutions (e.g. magnetic actuation) cannot. Piezo-actuators will be ruled out otherwise simply for cost reasons.
- Analyze your application correctly for the needed force-shift-characteristic. Pay attention to a suitable “piezo” match of your mechanical design. Only with a well-adapted application design, you can make complete use of an actuator’s performance including the benefits of high reliability, reproducibility and long operating life. The “upgrade” of existing old-fashioned mechanical designs by simply replacing a conventional drive by an “innovative” piezo-actuator will usually fail. Systems must be designed with the piezo-actuator in mind.
- A 100% general purpose piezo-actuator, covering all kinds of applications, does not exist. Piezo-actuators are typically optimized for distinct operation profiles. This degree of specialization may not explicitly be expressed in the data sheet. Therefore, care is needed when replacing successfully operating products by ones from other sources.
- The product data have been derived under distinct test conditions. The actuators may show a different behavior, when operated in a different way. The definitions of specifications for actuator’s performance can vary from supplier to supplier. Pay attention to the parameter definitions, when comparing elements from different sources.

- The lifetime and reliability of actuators depend strongly on the wide variety of the interacting operational parameters and the conditions of the individual application. Therefore, it is impossible to define a single test procedure, applied to an isolated element for evaluating its reliability for all kinds of operations. The only strategy is system testing under a set of realistic operation conditions. Even for a working piezo-mechanical system, small alterations of the driving conditions or system’s design may result in the need for a new suitability evaluation.

Do not misinterpret catalogue data:

Notice, that not all operating specifications can be realized at the same time due to simple physical facts.

Example:

- Maximum displacement/shift/stroke and maximum force generation /max. blocking force cannot be generated at the same time, only either-or.
- The real operating frequency of a piezo-mechanical system is usually held far below the actuator’s resonance frequency!



1.2 Characterizing piezo stack actuators

Stroke (shift) – force balances – dynamics – performance limits

Fig.1.2 shows a solid state actuator made by stacking PZT ceramic layers, which are electrically contacted individually resulting in a multilayer capacitor structure. The application of a voltage to the stack generates an electrical field within the ceramic layers resulting in a **mechanical strain** of the stack. The generated **axial expansion** of piezo **stack's length L** is used for actuation. Coupling to external mechanics is done via the end faces (cross section area A).

Achievable maximum strains typically range between 0.1% and 0.15% of L. A piezo stack with a length $L = 50$ mm usually possesses a maximum stroke of 50–70 μm .

The **load capability** and **max. force generation** of a piezo-actuator depend on stack's **cross section area A**. The load and force limits are in the range of 7–8 kN/cm^2 (70–80 MPa).

The mechanical work capability “stroke x force” is therefore proportional to the active ceramic volume $L \times A$.

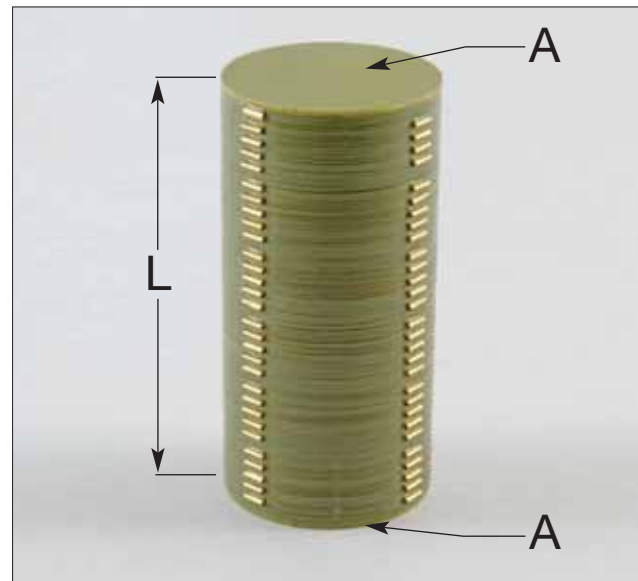

Fig. 1.2: Piezo stack built up from individually contacted piezoceramic discs
Working axis: length L
Active cross section area A (mechanical coupling face).



1.2 Characterizing piezo stack actuators

Specific features of piezo stack actuators

Shift:

unlimited positioning sensitivity
(actually proven down to the picometer range)

Forces:

- High load capability up to tons
- High force/pressure generation (kiloNewtons)
- Superposition of high static payload and dynamic force modulation
- Low mechanical compliance (high natural frequencies), solid-state body!

Dynamics: (depends also on electronics)

- No delay in mechanical reaction
- Very high acceleration rates
- Very high mechanical power generation

Design advantages:

- “Exotic” driving conditions applicable (vacuum, cryogenic temperatures etc.)
- Compact design
- High mechanical power density even in miniature structures (MEMS/NEMS)
- Power consumption only when motion is generated.
- No stand-by/no sustainer energy consumption.

Actuator market's main emphasis:

Shift:

Typical stack lengths 2–100 mm
=> shifts from μm up to approx. 100 μm

Forces:

Stacks with small to medium sized cross sections
(up to approx. 10 x 10 mm²)
=> Forces ranging from Tens to several Thousands of Newtons.
Low voltage actuators preferred.

Dynamics

Depends strongly on actuator dimensions
Non-resonant cycling with maximum strain: < 1 kHz
Non-resonant cycling with reduced strain: < 10 kHz

Performance limits

Exotic and expensive, mostly prototypes or singular applications

Shift:

High voltage stack actuators with length > 600 mm
for 1 mm shift (= 1,000 μm)

Forces:

Large cross section elements with diameters up to 70 mm for load capabilities, blocking forces > 100 kN
Mostly high voltage (HV) piezo stacks

Dynamics:

Piezo shock generator < 10 μsec rise-time for
100 μm stroke
Acceleration > 100.000 m/sec²



1.3 Actuator designs

Low voltage stacks: Co-fired multilayer actuators (CMA): also called “monolithic” stacks, involve no gluing, but a high temperature sintering of the complete ceramic-electrode pile. Operating voltages are up to 200 V. Rectangular cross sections are typical due to the ease of cutting processes in production.

High voltage stacks: Composite structures made by the stacking of separately finished piezoceramic discs and metal electrode foils that are joined through the use of adhesives. Operating voltages ranging from 500 V thru 1000 V are typical. Cylindrical shapes are most common.

Ring actuators: A stack with center bore: made with rings instead of discs. This type of actuator is available in both low and high voltage form.

Low voltage actuators are used for small and medium cross section (1 mm^2 up to approx. $14 \times 14 \text{ mm}^2$) fig. 1.3: B.

High voltage actuators cover needs for larger stack cross sections (fig. 1.3: A, C).

Ring actuators offer a wider range of design-options for piezo-mechanical assemblies (fig. 1.3: C, D, E).

Manufacturing of ring actuators is more elaborate and expensive than for bulk stacks.

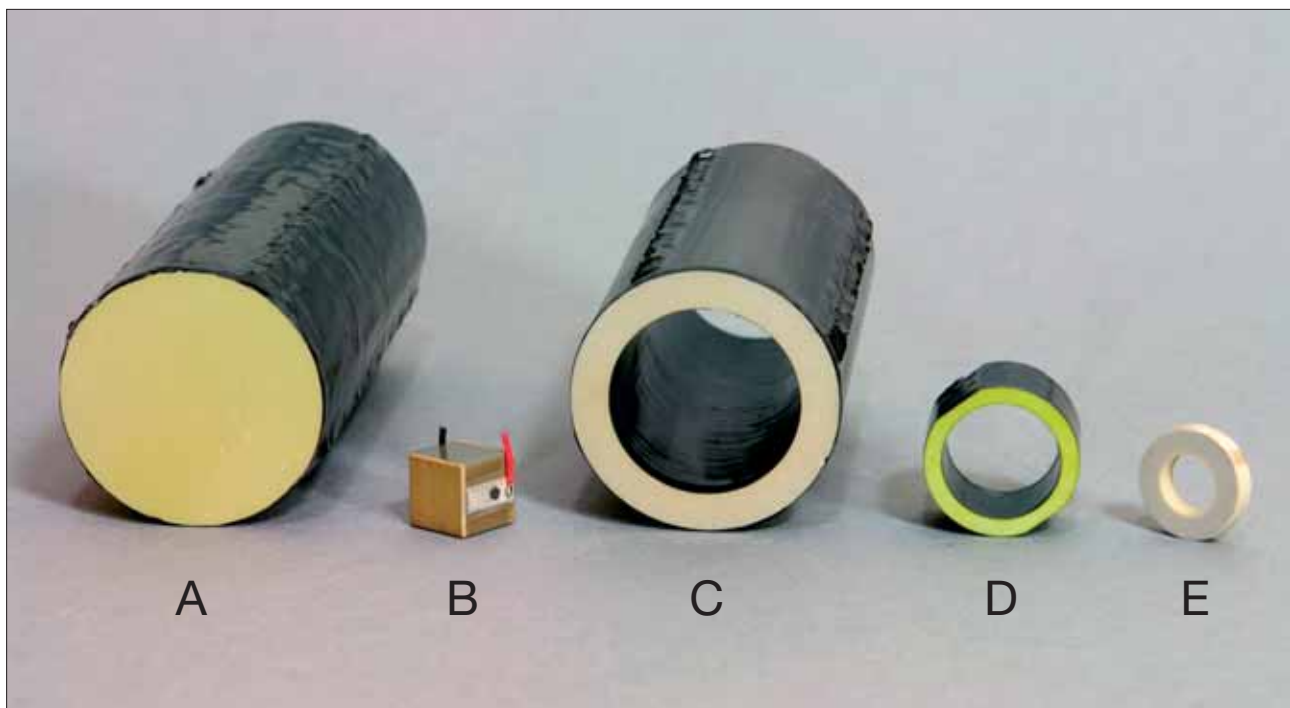

Fig. 1.3: (A), (C) high voltage bulk stack and ring actuator, large cross section
(B), (D), (E) low voltage bulk stack, ring actuator and ring chip

Basic stack designs

2.1 The piezo-mechanical effect

Piezo stack actuators are electrical multilayer capacitors, whose outer dimensions vary when the electrical charge status is changed. Usually the axial strain is used for actuation purposes.

The mechanical reaction like shift and force balance depends on the applied internal electrical field (typical values up to 2 kV/mm). To get the above stated levels of field strength with

acceptable voltage levels (100 V to 1000 V), the individual layer thickness of the multilayer stack will be adapted accordingly (e.g. 0.5 mm for a 1000 V high voltage actuator (fig.1.2)).

2.2 High Voltage versus Low Voltage: a comparison

Two completely different stacking techniques are used for low and high voltage stack actuators:

- Low voltage actuators (≤ 200 V): ceramic layers and internal metal electrode layers are stacked before the final high temperature sintering, while the ceramic is in the soft (green) state. The internal electrodes are a very thin metal film (thickness 1 μm) and are made e.g. of AgPd-alloy or Cu. This kind of actuator technique is often called as “monolithic cofiring”.
- High voltage actuators for voltage ranges of approx. 500 V up to 1000 V are made from completely sintered and finished individual PZT discs or plates prior to stacking. The inserted layer electrodes are made from separate thin metal foils. The whole arrangement is fixed together by a special high quality adhesive. Therefore HV actuators are not a ceramic monolith, but a kind of composite material.



Fig. 2.1: High voltage stack (black, left) and low voltage stack (green, right), mouse and USB stick for size comparison.



2.2 High Voltage versus Low Voltage: a comparison

	High voltage (HV)-stacks	Low voltage (LV)-stacks
Preferred use	large cross sections > 15 mm For special actuator designs, small and medium quantities	small and medium cross sections miniature elements, lower costs for large quantities
Individual ceramic layer thickness	up to 0.5 mm typ.	< 0.1 mm typ.
Manufacturing process	gluing of individual completely finished PZT-ceramic parts like discs or plates	piling up of soft, non-sintered PZT-ceramic sheets and elec- trodes. High temperature sintering of complete stack structure
Max. driving voltage	500 V - 1000 V	up to 200 V
Max. electrical field	same for both types: approx. 2kV/mm typ	
electrical capacitance/cm ³ (order of magnitude only)	100 nFarad	2.5 μFarad
Elastic modulus	lower for HV elements, when not mechanically preloaded	high: up to 90% of theoretical value of the original PZT-ceramic
Max. strain	same for NV and HV stacks: approx. 0.1 – 0.15%	
Max. pressure load	same for NV and HV stacks	
Max. force generation	same for NV and (preloaded) HV stacks	
Positioning accuracy	same for NV and HV stacks	
Max elec. energy densities	same for NV and HV stacks (approx. 0.3 Ws/cm ³ , depends on PZT material)	



2.3 Stack configuration

Most customers relate the functionality of a piezo stack only to the used piezoceramic material. However, it is a common experience that all aspects of the stack design, manufacturing technique and finish of the whole component are essentials regarding performance and reliability.

Following points require attention:

- joining techniques
- electrode design
- internal insulation techniques
- surface insulation techniques

All of the structural components of a stack are subject to strongly varying mechanical and electrical load conditions during dynamic cycling.

Further upgrades of the stack actuator are the use of metal casings with internal pre-stress mechanisms (fig. 2.2) and other options like internal heat management, position sensing etc. (=> chap. 6: Options)

This leads to very different levels of reliability when considering different actuator concepts for a distinct application.

Piezo stacks from different sources will differ not only in the used ceramic, but also in different manufacturing techniques. These differences are not necessarily expressed in the short term performance data. Careful evaluation of the proposed piezo stacks must be undertaken when an application requires high reliability.

PIEZOMECHANIK stack actuators range from general-purpose elements for low and medium dynamic applications up to specially designed elements for very high mechanical dynamics.



Fig. 2.2: Schematic of integration of a piezo stack into a preloaded casing



2.4 Ring stacks versus piezo tubes: a comparison

Piezo tubes are simple ceramic cylinders with metalized inner and outer surfaces. For mechanical stability reasons, the wall thickness of such tubes needs to be about ≥ 0.5 mm (fig. 2.3, A). To get maximum displacement, high voltages are applied. Piezo tubes are sometimes used as simple positioning mechanism, when access to the system's axis is needed.

Piezo ring actuators can be a much more efficient alternative.

By applying a center bore, piezo stacks can be built up as hollow cylindrical elements, (fig. 2.3, B) offering a much wider range of design opportunities for piezomechanics.

Piezo ring actuators were first offered to the market by PIEZOMECHANIK in the 1980's .

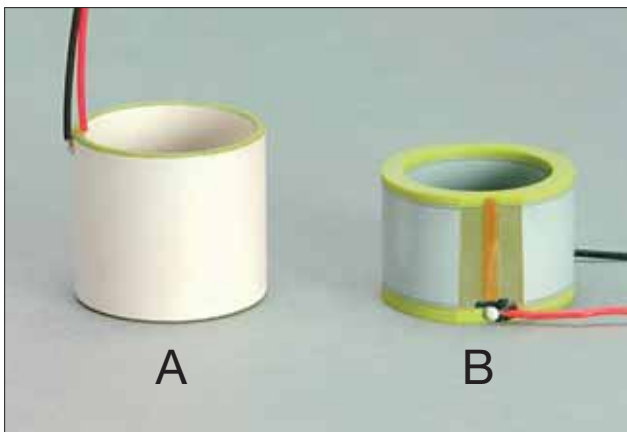

Fig. 2.3: Piezo tube (A) versus stacked cylinder (ring actuator (B))

Compared to piezo tubes, a ring actuator offers the following advantages

- Higher strain rates achievable (axial strain efficiency at least better by a factor 2)
=> compact design
- **Low voltage types available**
- Wall thickness independent from driving voltage levels

Attention:

Piezo tubes make use of the contractive d_{31} piezo-effect.

Piezo ring actuators make use of the expanding d_{33} piezo-effect showing doubled strain efficiency of the d_{31} operation.

The change of sign in motion shall be kept in mind when setting up e.g. a feed back controlled system.



2.5 Ring stacks versus bulk stacks: a comparison

Ring actuators show specific features and advantages in comparison to bulk stacks.

- Higher bending stability:
When comparing the same volume of active ceramic material a ring actuator has a larger total diameter than the bulk stack. Accordingly, this larger diameter results in an increase of mechanical stability against bending and buckling. This is important, when long-stroke stacks are set up showing a rather critical aspect ratio length/diameter. To compensate for this, larger diameters are needed.
When using a bulk design, the electrical capacitance increases dramatically for mechanical stability reasons only. The electrical power consumption increases equivalently, but is not needed on the mechanical output side. The overall power efficiency is going down (mismatch).
By using the hollow cylinder ring actuators design, the mechanical stability is enhanced without the increase of electrical capacitance.

- Efficient heat management:
Piezo-actuators generate heat when operated dynamically with high repetition rates. This heat must be removed from actuator ceramic. Overheating will lead to worsening of actuator performance and/or cause damage.
It is a fact that piezoceramic is characterized by poor thermal conductivity that rules all heat management measures. The length of the heat diffusion path and the available actuator surface determines the quantity of heat removed from the ceramic volume. In terms of heat management efficiency, the ring design is favored over the bulk stack with respect to these parameters. (=> chap. 5.3) Hence, ring-type actuator can run much higher non-resonant frequencies than bulk stacks without the risk of heat damage.

Ring actuators are more elaborate and expensive than bulk elements.

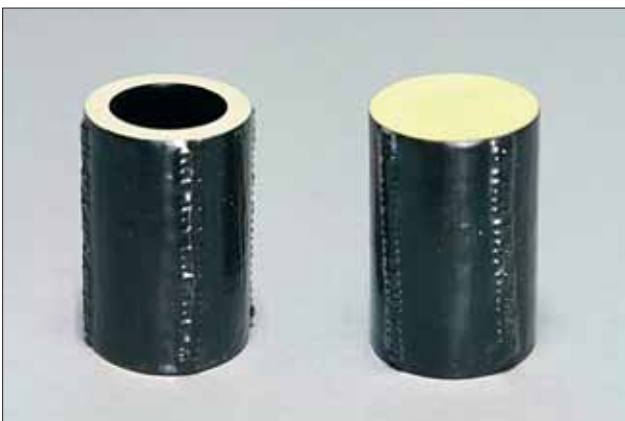

Fig. 2.4: Ring stack versus bulk stack



2.6 Advantages of PIEZOMECHANIK's piezo stacks

All structural components of piezo-actuators are subject to potentially high mechanical loading not only during operation, but also during handling and mounting.

Be careful: piezoceramic components are mechanically sensitive devices.

- Local mechanical stress concentration creates potentially “cracks” within the piezoceramics, leading to a weakening of the electrical “stability” of the ceramic.

PIEZOMECHANIK takes care about these risks by using two different insulation concepts for different actuator applications.

- **on stack insulation** (osi-design) (fig. 2.6)
Used for PIEZOMECHANIK's
high voltage actuators (H)PSt 500/1000
low voltage stacks (H)PSt 150

The insulation gap is prepared **on** stack's surface. Therefore the piezoceramic cross section of a stack is 100% electroded and activated homogeneously.

- highest actuator performance, high blocking forces
- no local field distortion etc.
- no local stress spots are induced
=> no cracks are generated etc.

Last, but not least: osi-designed stacks show high resistance to bending forces.

- The electrical and mechanical stability of the supply electrodes is important for the overall reliability of a stack actuator when operated dynamically.
- A major design topic is the handling of the necessary insulation gap between internal electrodes and supply electrodes of opposing polarity. Point of attention is a potential local distortion of electrical field in the vicinity of such an insulation region. By the piezo-mechanical coupling, this leads to a local mechanical stress concentration with subsequent crack generation and a potential failure of the stack by electrical short-circuiting.

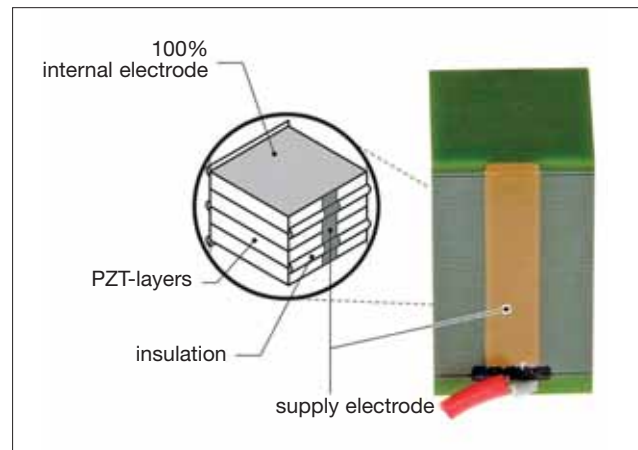

Fig. 2.6: on stack insulation (osi)-design, insulation is done outside the active stack



2.6 Advantages of PIEZOMECHANIK's piezo stacks

- **in stack insulation** (isi-design)
Used for PIEZOMECHANIK's
PSt-HD 200 stacks
Piezo chips (H)PCh 150

This is a widely used "classical" technique using an insulation gap **within** the stack's volume (=> fig. 2.7). The stack volume is not completely activated. Therefore performance reduction occurs for miniature stack cross sections. Here occurs additionally the stress spot concentration problem. To avoid catastrophic crack generation and propagation different countermeasures are provided.

One technique applies small notches or grooves to the stack's surface for getting a "soft" surface to reduce mechanical stress concentration.

Isi- stacks are less stable against bending forces due to surface weakening by the notch-effect (in comparison to osi-stacks).

To improve the mechanical stability, isi-stacks are mostly used in a high-preloaded arrangement.

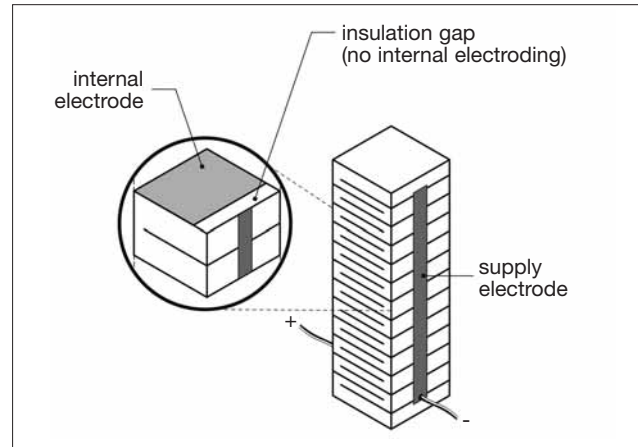

Fig. 2.7: in stack insulation (isi)-design, insulation is done inside the PZT-stack

- **High cycle fatigue resistant electrodes**
All piezo stacks show the supply electrodes attached onto the piezo stack's side faces. These electrodes are subject to remarkable strain and acceleration induced stress during dynamic cycling. Additionally a high electrical current loading occurs, where special contact techniques are needed to transfer high powers without losses to the ceramic structure.

PIEZOMECHANIK is the expert for this kind of non-resonant actuator operation. Suitable insulation and contact techniques allow the reliable operation of its actuators with high power levels.

Precision Positioning

Piezo stacks are widely used for precision positioning tasks: a component shall be moved with sub-micron accuracy from one position to another.

Most piezo-mechanical systems for this purpose show a special trait: nearly no alteration of system's internal force balance occurs during piezo action. Only then, piezo stack's expansion maximum is achieved.

Piezo stack actuators expand, when they are charged up from a voltage U_{\min} to U_{\max} . The motion is reversed, when the actuator is discharged. The (reasonable) maximum strain rates are about 0.1 – 0.15% of the actuator length. Exaggerating strain by applying too high electrical fields is adverse to reliability.

For sub-resonant operation, the piezo stack motion follows the applied voltage signal instantaneously. The electrical behavior of piezo-actuators is like that of a capacitor.

Precision positioning is mostly done by voltage control of piezo stacks.

The stroke of a piezo-mechanical system can be increased by lever-constructions, where amplifying factors n of 10 are achieved without big efforts. But keep in mind:

- load capability is reduced to $1/n$
- the compliance of the complete system increases by n^2 compared to the original stack data.

3.1 Shift versus voltage characteristic

Correlation of piezo stack's open-loop cycle over a voltage range $U_{\min} - U_{\max} - U_{\min}$ leads to the hysteresis diagram fig. 3.1.

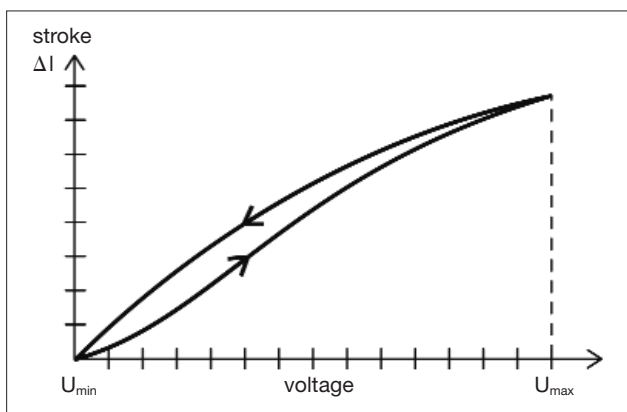

Fig. 3.1: Schematic of a piezo stack's stroke/voltage diagram by cycling the stack within the voltage range $U_{\min} - U_{\max} - U_{\min}$.

Attention:

do not over-interpret the open-loop stroke-/voltage-diagrams, they are not high resolution calibration curves for practice!

- The exact shape of the hysteresis cycle (fig. 3.1) depends on the applied cycling voltage range. For very small voltage variations, the response looks much more linear rather than like a loop (small signal versus large signal excitation).
- An acceptable reproducibility of the hysteresis diagram is achieved only after reaching an equilibrium attained by cycling the system many times while all other operation parameters like temperature, force and load are held very constant. If the cycling conditions are changed the system will adjust towards a new equilibrium after the application of a sufficient number of cycles.



3.1 Shift versus voltage characteristic

- The exact shape of the diagram fig. 3.1 depends on the cycle time.
The slower the cycling is applied, the wider the hysteresis becomes due to the slow poling effects of the piezoceramic structure. These poling effects are also the reason for creep upon the application of a voltage step to the piezo stack.
- When an open-loop random (non-periodic) setting of the voltage input is applied, a field of positions is generated, where the cycling hysteresis is the envelope of this field (fig. 3.2).
With other words: the final position of the stack upon application of a distinct voltage level depends on the “history” of stack’s operation (memory-effect for open-loop)

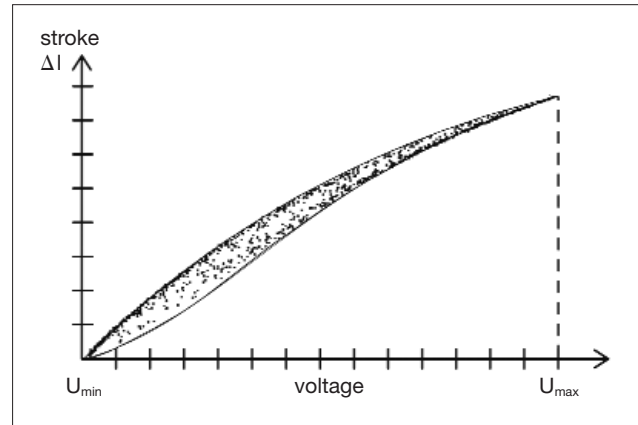

Fig. 3.2: Field of positions by open loop random generation of voltage steps. The uncertainty in positioning by random position setting is about 10% of the operation range, defined by U_{min} , U_{max} .

A lot of attempts have been made to overcome the need for position feedback for piezo precision positioning, but the success was limited

- A, algorithms have been developed for piezo-actuator computer control to compensate for the “ferro-effects” of PZT ceramic like non-linearity, hysteresis and memory-effect.
- B, electro-strictive ceramics have been used (=> chap. 8) instead of PZT ceramics.
- C, charge or current control has been applied instead of voltage control (=> chap. 9.2)

All methods have been limited in effectiveness e.g. to non-linearity etc. of about 1% and are not really suited for open-loop ultra-precise positioning. Options A and B are not used in common practice. Option C, is an interesting technique for dynamic actuator operation for other reasons, but not for precision positioning.

Notice:

Even when an open-loop perfect actuator would be available, it only partially solves the problems of precision positioning.

In most cases, piezo stacks are prime movers of coupled mechanical devices for motion transfer. In practice, these mechanics possess inherent imperfections. Without high accuracy position sensing and information feedback to the actuator, these deficits are not recognized and are self-evidently not compensated for by open-loop actuation.

Even the simplest adjustment procedure in laboratory by turning the voltage control knob of a manually set voltage supply is a kind of feed-back control: The operator checks for the correct result (e.g. a distinct interference pattern in optics)



3.2 Precision positioning by piezo stacks

The unique feature of piezo-actuators:
the infinitely high relative positioning sensitivity Piezoceramic converts an infinitely small voltage variation into an infinitely small motion.
This has been proven explicitly down to the picometer range.

As seen in chapter 3.1. very high precision positioning with an accuracy better than 1% of actuators maximum stroke position-sensing and feed-back control is needed. Then the piezo-actuator is able to carry out the finest corrections to come nearest to a desired pre-set position. In this case, hysteresis, creep, and non-linearities are ruled out automatically.

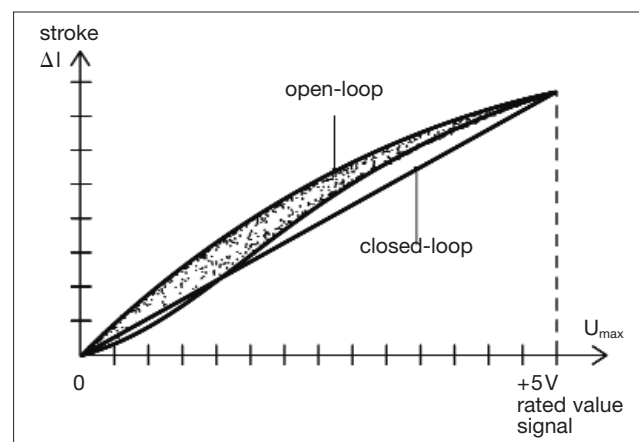

Fig. 3.3: Schematic comparison of the open loop and feed-back controlled closed-loop operation of a piezo-system

Notice:

*A feedback philosophy handles only all misalignments of the piezo-mechanics between actuator and position sensor. Misalignments **outside** the closed loop path are **not compensated** for. Piezo-actuators with integral position sensor can handle all internal “imperfections” (hysteresis, drift, non-linearity) and all effects as long as they are acting back to the actuator’s strain (e.g. load variations).*



3.3 Limits of positioning accuracy

The accuracy of a piezo-positioning system is usually not limited by the piezoceramic or piezo stack. This has been explicitly proven down to the picometer range. Nevertheless, in a complex piezo-mechanical positioning system, there are influences outside the actuator resulting in a potential limitation of accuracy.

- quality of electronics:
any noise and electrical fluctuations will be converted in its mechanical equivalent
- the accuracy of the position sensor and its location within the piezo-mechanical system (extension of the control path)
- quality of the attached mechanical transfer-mechanisms Microscopic friction, stick-slip effects in bearings, hinges, preload mechanisms will limit the overall accuracy of the piezo-mechanical system
- Tilting of stack's end faces:
A piezoceramic stack shows, to some extent, a tilting of its end-faces during the axial expansion.

Simply laboratory style optical arrangements with a glued sandwich of substrate/piezo stack/mirror work tilt-free only over short shifts (\Rightarrow 7.6).

Tilting can be reduced by mechanical preloading of the stack (\Rightarrow chap. 4.9). A tilting up to several μrad / μm shift occurs typically. Consequent cancellation of tilt for a longer stroke is only possible by adding a guiding mechanism.

- **piezo-based stabilization circuits**

A special kind of precision control is the stabilization of position sensitive physical effects. The optical output power of laser resonators depends on the alignment of the whole opto-mechanical set-up. To keep the resonator in its power maximum despite misaligning influences the optical output power is monitored. By applying a proper tracking algorithm to discriminate the power maximum, the laser can be kept by piezo in its (relative) power maximum (see: dithering principle, optical tracking, OptiSeek controller). Similar set-ups are also used for free optical fiber coupling.

Tips to catalogue data

- The maximum actuator shifts (strokes) in data sheet are only valid under constant load conditions (no force variation!).
- Two values for Δl are stated in the data sheet
A, for the unipolar activation $0 \text{ V} / +U_{\text{max}}$
B, for semibipolar operation $-U_{\text{min}} / +U_{\text{max}}$
The semi-bipolar operation increases the open-loop stroke of a stack by 20 – 30 %.
Any kind of stack actuator is suitable for semi-bipolar operation at room temperature.

- **Example**

Piezostack PSt 150/5x5/20
Unipolar operation $0 \text{ V} / +150 \text{ V}$: stroke $20 \mu\text{m}$ e.g. with a PIEZOMECHANIK LE 150 unipolar power amplifier
Semi-bipolar operation $-30 \text{ V} / +150 \text{ V}$: stroke $27 \mu\text{m}$ with a PIEZOMECHANIK SVR 150 amplifier

Motion and Forces

4.1 Beyond simple positioning

New applications of piezo-actuators are often requiring force generation together with the variation of position.

Attention has to be paid then to a few additional aspects compared to chapter 3.

To select a suitable piezo-actuator careful analysis of the actuated mechanics by the user is required as follows;

A, required mechanical shift l_{mech} to move the mechanics properly?

B, force level F_c within the mechanics at the beginning of piezo action?

C, total force level within the mechanics at the end of piezo action at maximum voltage?

➔ The difference of B,C defines the required force generation ΔF_{mech} by the piezo-actuator

➔ The ratio $\Delta l_{\text{mech}}/\Delta F_{\text{mech}}$ is the compliance (inverse stiffness) of the mechanical system



4.2 Examples for force / shift relations

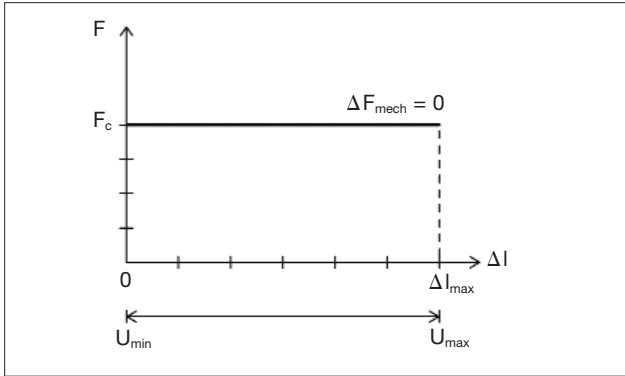

Fig. 4.1:

Gravitational mass load of a piezo-actuator

The force level F_c remains absolutely constant during piezo action. The maximum piezo shift ΔI_{\max} is achieved (according data sheet).

The piezo-actuator generates a translatoric mechanical energy $F_c \Delta I_{\max}$.

Applications: precision positioning of heavy loads like telescopes, precision manufacturing machines.

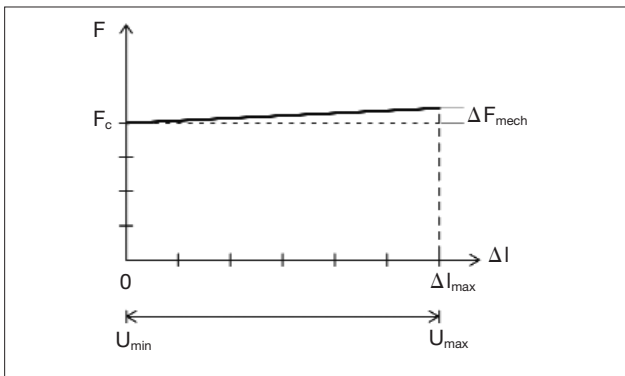

Fig. 4.2:

Piezo-actuator expands against the counterforce of a weak spring

(elastic medium with high compliance/low stiffness)

The actuator is preloaded with a force F_c .

The expansion of the piezo-actuator leads only to a small increase ΔF_{mech} of the force balance.

It is found, that the piezo-actuator produces (nearly) its maximum shift (data sheet).

A mechanical energy $F_c \Delta I_{\max}$ is produced (first order). Application: common optomechanics with reset springs.

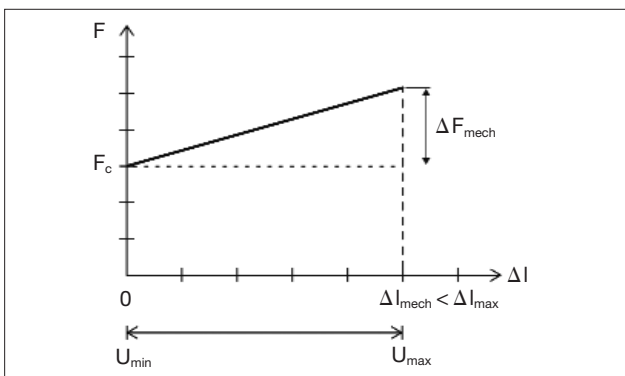

Fig. 4.3:

Piezo-actuator produces a shift against a strong spring

(elastic medium with low compliance/high stiffness)

The actuator is preloaded by the spring with a force F_c . The expansion of the piezo-actuator leads to a remarkable increase ΔF_{mech} (= elastic force ΔF_e) of the total force balance.

The piezo shift ΔI_{mech} is reduced compared to the data sheet value. The total energy generation is $(F_c + \frac{1}{2} \Delta F_e) \cdot \Delta I_{\text{mech}}$,

$\frac{1}{2} \Delta F_e \Delta I$ is the elastic energy put into the system by piezo action. Application: motion control.

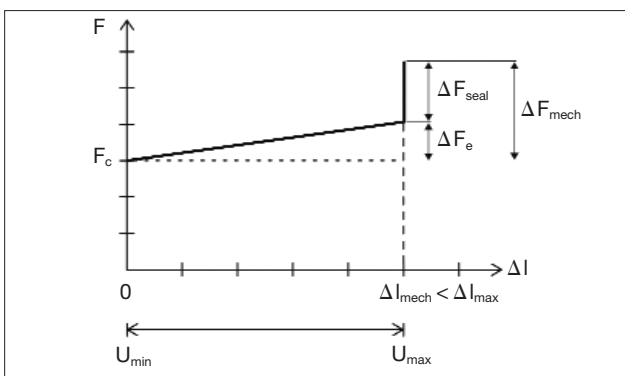

Fig. 4.4:

Valve actuation: piezo-actuator shift closes valve

The actuator is again preloaded by a hard spring resulting in a base force F_c and an elastic force ΔF_e when moving. The final step of the voltage swing $U_{\min} - U_{\max}$ is used to build up the sealing force (press fit). This final force variation F_{seal} is not accompanied by a motion (so-called blocking condition).

The total achievable stroke is again less than the maximum shift specified in data sheet.

The total achievable stroke is again less than the maximum shift specified in data sheet.

Fig. 4.1 – 4.4: Different kinds of stroke-force profiles of mechanical arrangements



4.3 Piezo-actuator as an active spring

From a physical point of view, the piezo stack is an active spring:

When a piezo-actuator generates an external force ΔF , it does not only compress the mechanical partner, but the force acts back on the stack itself. This “self-compression” of the actuator reduces the effective external stroke of a piezo stack correspondingly (depending on actuator’s stiffness).

Blocking force

The force generation limit is reached, when the piezo-actuator is clamped rigidly with zero compli-

ance. Because no shift can be generated, the complete piezo activation is used to build up a force variation.

This maximum force generation limit of a piezo stack is called “blocking force”.

In data sheet, the max. blocking force for maximum voltage ratings are shown (both, for unipolar or semi-bipolar activation).

The blocking force ΔF_{block} of a piezo stack depends on stack’s cross sectional area A (fig. 1.2), but not on length L .

4.4 Selecting a piezo stack

You have analyzed your mechanics and application with regard to the required stroke-force activation profile (ΔF_{mech} , Δl_{mech}), no dynamic forces (=> chap. 4.1, => chap. 10).

1st step:

Select the suitable actuator group with respect to its force balance, which is related to actuator’s crosssection.

- sufficient high load capability
- data sheet blocking force at least double the needed force generation ΔF_{mech} for your application.

■ Example to 1st step

Your mechanism needs a preload F_c of 2 kN and a force generation of 1 kN.

This is covered by piezo stacks PSt 150/10x10/xx or PSt 150/14/xx VS 20 actuators with casing

2nd step:

Within the actuator group selected according step 1, a suitable actuator length is chosen by numerical or graphical means .

A, numerical solution

Remember that a piezo-actuator is an active spring! The stroke is reduced the more as the ratio of

$\Delta F_{\text{mech}}/\Delta F_{\text{block}}$ increases. To get the needed stroke Δl_{mech} for activating your mechanics, the actuator with data sheet stroke Δl_{max} is required.

$$\Delta l_{\text{mech}} \leq \Delta l_{\text{max}} (1 - (\Delta F_{\text{mech}} / \Delta F_{\text{Block}})) \Rightarrow \Delta l_{\text{max}} = \Delta l_{\text{mech}} \Delta F_{\text{Block}} / (\Delta F_{\text{Block}} - \Delta F_{\text{mech}})$$

Δl_{max} (max. stroke) and ΔF_{block} (blocking force) are found in actuator’s data sheet.

Δl_{mech} , ΔF_{mech} actuation data, required by the attached mechanics



4.4 Selecting a piezo stack

B, Graphic solution

Fig. 4.5 shows a coordinate triangle defined by the data sheet values Δl_{\max} and ΔF_{block} of a potential piezo-actuator candidate.

The actuation data Δl_{mech} , ΔF_{mech} define an origin based stiffness line with the intersection with the triangle at point A.

If the coordinates A (Δl , ΔF) of an actuator are equal with your requirements (Δl_{mech} , ΔF_{mech}), then the actuator is suitable to drive your mechanics. Usually, an actuator is selected to keep the point A in the upper half of the triangle.

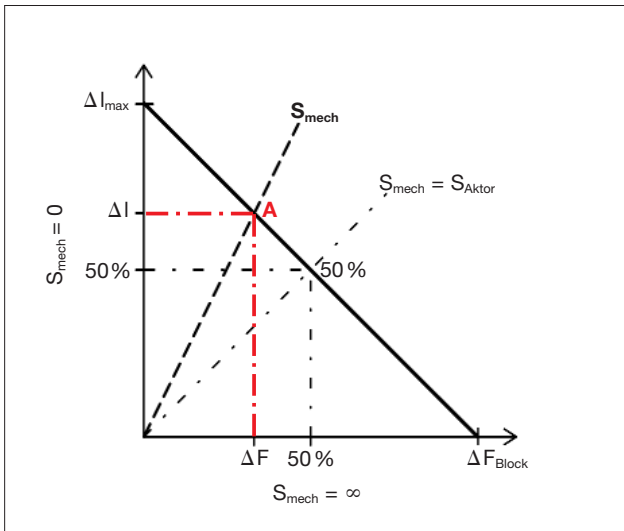

Fig. 4.5: stroke/force-triangle with intersecting stiffness-line defined by the operated mechanics.

Comments:

- The above mentioned strategy is a linear approximation of the more complicated ferro-electric behavior of a piezo stack. Utilize a reasonable tolerance range and do not aim for unreasonable "point-precision".
- Surprise is sometimes created by the fact, that a heavy, but constant load does not reduce actuator's maximum stroke. The reason is rather simple: the load condition is applied to the piezo stack before operating the stack e.g. a mass load or a low stiffness preload is applied during mounting the system! This compression of the stack creates the necessary counterforce to bear the load, so the system is in force equilibrium before starting the piezo-action. No additional force generation ΔF by piezo needed => full piezo stroke!
- When actuator and the driven mechanics show the same stiffness $S_{\text{actuator}} = S_{\text{mech}}$

The effective shift and generated force show 50% of the data sheet values. This configuration allows the highest elastic energy transfer E

$$E = 1/8 \Delta l_{\max} \Delta F_{\max}$$

Dynamic operation:

For dynamic operation, acceleration forces of the involved masses need to be taken into account. A good method for selecting an actuator is to aim for a resonance frequency of the system to be at least twice the desired maximum operation frequency.



4.5 Force generation

In a formal way, the blocking force is defined as the achieved force generation of a stack when it is clamped with “zero compliance”. “The actuator does not move, when a voltage is applied.” In real nature, all materials show a limited elastic modulus that does not allow infinitely high stiffness by passive means.

But using a closed-loop active arrangement, the blocking situation can easily be verified as shown below: A piezo-actuator is equipped with strain gauges and mounted into a mechanical press. A load cell is applied in series with the actuator. The whole system is electrically operated with PIEZOMECHANIK’s feedback control positioning system, PosiCon 150.

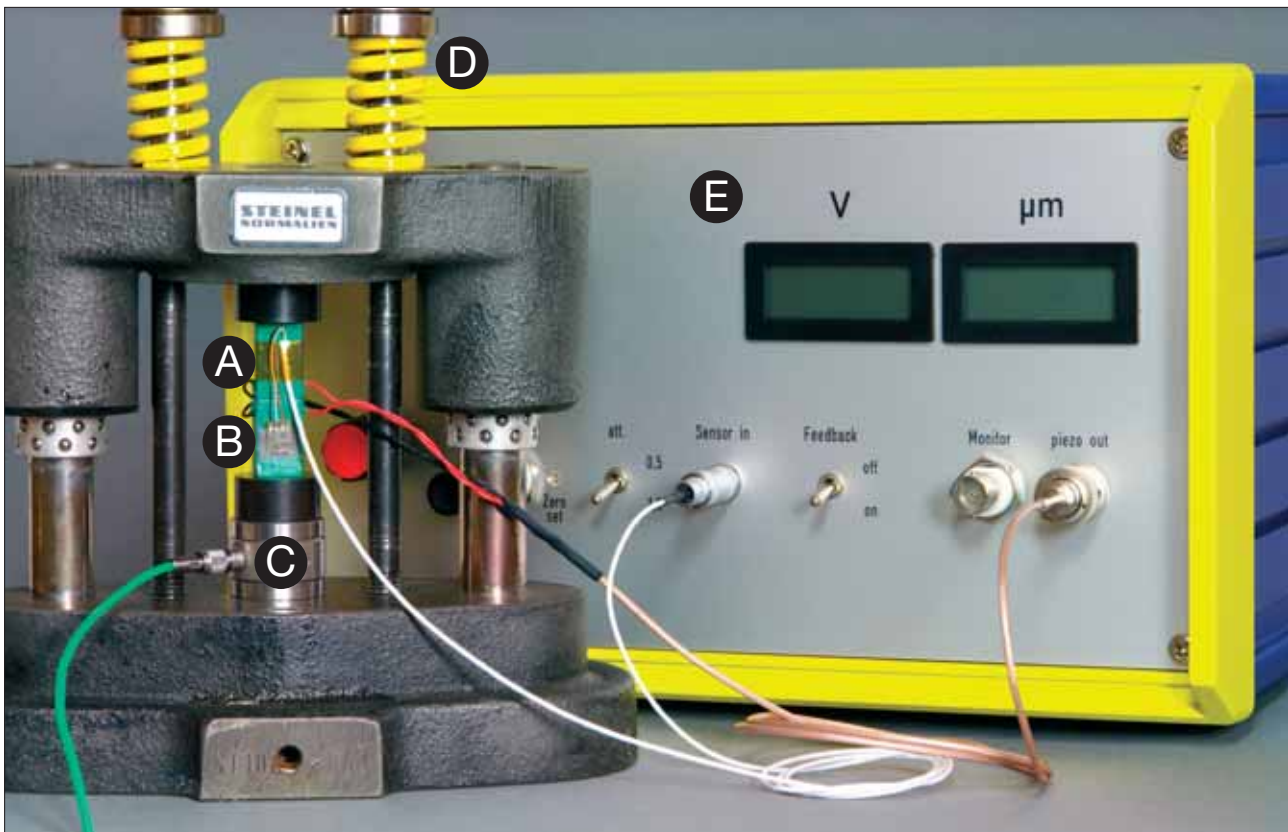

Fig. 4.6: arrangement for blocking force determination with a PSt 150/10x10/40 piezo stack

A Piezo stack (green)
B strain gage on stack
C load cell

D compression springs
E position control electronics PosiCon 150



4.5 Force generation

Experiment:

- Used piezostack: PSt 150/10x10/40, maximum operating voltage 150V
- a, Zero-position of piezostack defined by setting of the “Offset” voltage
 - Case 1: 0 V unipolar operation
 - Case 2: -30 V semi-bipolar operation
- b, “0 V” to input of PosiCon electronics (closed-loop-mode)
With this condition, the control-loop tries to keep stack’s zero-position constant, when load force varies.

Results:

- The piezostack PSt 150/10x10/40 shows the following maximum blocking forces
 - Case 1: unipolar mode (equivalent 0 V/+150 V activation) : 6500 Newtons
 - Case 2: semi-bipolar mode (equivalent -30 V/+150 V activation) : 7800 Newtons
- A linear relation between the force variation and compensating voltage has been found for the PSt 150/10x10/40 stack (fig. 4.7).
- The blocking force is equivalent to the maximum load variation on a piezo stack that can be compensated for by a feedback closed-loop position control.

Example

A piezo stack PSt 150 (max.operation voltage +150 V) is set to a distinct position by 90 V activation. This position shall be kept constant by closed-loop operation. The maximum increase of load force what can be compensated for corresponds to the “60 Volts blocking force” of the stack.

- Test procedure: The pressure load on the stack is now increased continuously and monitored by the load cell. The position of the actuator is held constant via closed-loop-control (see b). => the piezo voltage is increased correspondingly by the PosiCon-electronics to compensate for the compression of stack’s length. The load limit is reached, when the compensating voltage reaches + 150 V. This arrangement reflects exactly the blocking condition: force variation within the piezo-mechanical system without a motion of the actuator (virtually infinitely high stiffness of actuator).

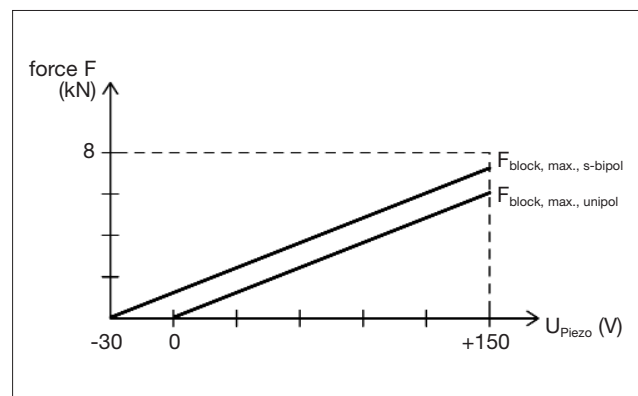

Fig. 4.7: Blocking force versus excitation voltage for piezo stack PSt 150/10x10/40 (uni-polar and semi-bipolar operation range)



4.6 Stiffness

A very significant feature of a piezo-mechanical actuator is the dependence of its stiffness (inverse compliance) on the electrical operating conditions.

Test arrangement:

- A piezo stack PSt 150/10x10/20 (with strain gage) is compressed by a 2 kN axial load force and the resulting compression is measured in a similar arrangement as shown in fig. 4.6. The compression of the stack is measured via the strain gage together with a DSM 01 strain gage amplifier or the PosiCon 150 electronics in its open-loop mode.

- The actuator stack is subject to a compressive load

A: with the leads short circuited
B: with the leads open : fig. 4.8

The load force is monitored by the load cell (fig. 4.6).

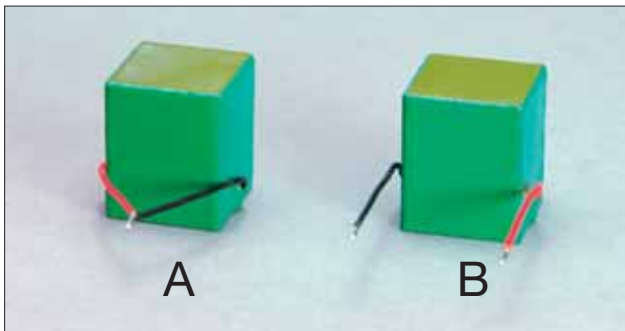

Fig. 4.8: Piezostack PSt 150/10x10/20 with closed (A) and open (B) leads

Results:

Two different stiffness values $\Delta F/\Delta l$ have been found

- (A) => approx. 200 N/ μm
- (B) => approx. 450 N/ μm

Physical background:

The reason for the varying stiffness is the original piezo-electric effect: electrical load generation by mechanical pressure.

In **case (A)**, this charge can flow and is removed from the stack, whereas in case (B) the charge

remains within the stack. Hence a voltage at the leads is generated by mechanical means! This is equivalent to the electrical field within the piezoceramics. This electrical field stabilizes the piezoceramic against compression.

Consequences for practice:

The situation (A) with closed leads is equivalent the operation of piezo stacks by voltage control. Mechanically generated electrical charge flows towards the voltage supply to keep the actual voltage constant. The mechanically generated electricity is dissipated!

Case (B) is equivalent the charge- or current control philosophy (=> 9.2).

The mechanically induced electrical charge remains in the actuator, the actual actuator voltage varies with the load variations.

The advantage of the lower open-loop compliance by current control is preferentially used in dynamic motion control.

The highest system stiffness is achieved by closed loop position control (virtually infinitely high stiffness, => 4.5). However, the response-time (bandwidth) of feedback controlled systems is slower when compared to the open-loop current control.



4.6 Stiffness

Piezo-actuators with casing

The stiffness values shown in data sheet are defined for force coupling via the end-pieces of the actuator.

When actuators with casing are mounted via the casing tube (by clamping or front threads of the piezo cartridges FPSt), a reduction in the overall stiffness must be taken into account, because the force path involves both the stack and the casing. Notice:

The overall stiffness of a piezo-mechanical system depends on all involved mechanical parts :
“Weak” points are often poorly designed coupling joints.

The implementation of “motion magnifiers” like levers reduces the overall stiffness for basic physical reasons:

Hybrid systems with motion magnification (factor n) reduces

- the blocking force down to $1/n$.
- the total stiffness of a piezo-actuated system down to $1/n^2$!
(compared to actuator’s original data)

Comments on data sheet

A voltage controlled piezo stack shows approx. 20% of the stiffness of a steel rod of same dimensions.

The elastic property of poled piezoceramics differs remarkably from common materials

- it is anisotropic (depends on the direction of force and poling axis)
- it depends on the applied field variation (small signal versus large signal excitation) (= > 8: PZT materials data)
- stiffness depends to some extent on the pre-load conditions

The data sheet values for stiffness are defined for small-signal variation and voltage control. Keep a tolerance range of +/-20% in mind. Catalogue data are best used for a kind of trend analysis.



4.7 Force limitations, load capabilities

The maximum load force shown in the data sheet is the steady load F_c according chapter 4.2. Within this preload range, the full motion and force generation capability of an actuator can be used.

For higher preloads F_c , the PZT-ceramic performance decreases as a consequence of de-poling effects

(reversible!). Mechanical damage does not occur (Damage threshold up to 10 times larger than the de-poling limit)

Only for very large aspect ratios length /diameter > 15 , bending and buckling of the stack becomes a concern.

4.8 Dynamic operation

Piezo stacks can be operated with very high dynamics with acceleration levels of thousands of g.

Mechanical aspects

A rapid activation of a piezo stack creates potentially tensile forces by negative acceleration. (e.g. when slowing down stack's velocity after a pulse excitation or by a stack's contraction).

Even for an otherwise unloaded stack pre-stressing is recommended, when switching rise-/fall-times below 1 msec occur.

The necessary preload level can be high as 50% of the maximum load level depending on the individual configuration.

Generally, for every highly dynamic application, the stack design needs to be adapted accordingly.

Standard actuators from catalogue will fail.

Electrical aspects

Use power supplies well-matched to your application with respect to voltage and current levels (power). Oversizing electronic's performance leads to potential mechanical or electrical overload of the piezo-mechanical system.

Take care for correct electrical installations: pulsed actuator discharge by accidental short circuiting is a proper way to kill the stack.



4.9 Mechanical preloading (pre-stress)

Data sheet for the mechanical properties of PZT-ceramics show a small tensile load capability of a few percent of the compressive damage threshold. Nevertheless it is strongly recommended to avoid piezo-mechanical designs that systematically place the stack under a tensile load. Even when the regular operation keeps the actuator within the “safe” tensile stress area, any accidental mechanical or electrical overload (by external shocks or irregular signals) can kill the ceramic stack.

A piezoceramic stack is mainly a pusher-element: Any demanding application uses mechanical preloading (= pre-stress) to keep a stack in any situation and moment under compression.

(antagonistic operating principle).

Preload systems are mostly based on passively acting force-storing principles like mechanical, hydraulic or pneumatic springs.

Designing a preload mechanism:

- The maximum stroke of a piezo-actuator shall not be reduced by the preload mechanism. According chap. 4.2, the spring constant (stiffness) of the preload spring needs to be very low: a few percent of piezo-actuator’s stiffness in maximum.
- The preload force shall be sufficiently high to accelerate all incorporated masses sufficiently fast during the actuator’s contraction to avoid tensile loading of the ceramic. The dynamic force F_{dyn} can be estimated by the well know acceleration/force-law

$$F_{\text{dyn}} = m \Delta l / \Delta t^2$$

Notice:

the preload mechanisms shall not only take into account the force balances during regular operation, but shall also stand potential external shocks.



4.9 Mechanical preloading (pre-stress)

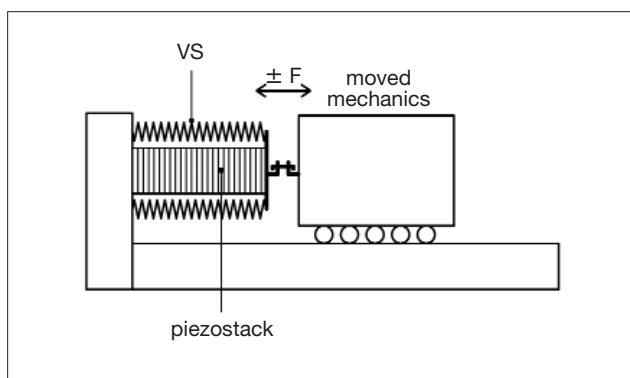

Fig. 4.9. **Internal preloading:**

The preload mechanism VS is integrated into the actuator casing. Typical configuration of actuators with casing like PIEZOMECHANIK's PSt ... VS elements.

Externally applied tensile forces can be handled up to the preload level.

Dynamic cycling of an external mechanic leads to force loads with alternating sign. Coupling joints need careful design to handle this situation without fatigue and play/backlash.

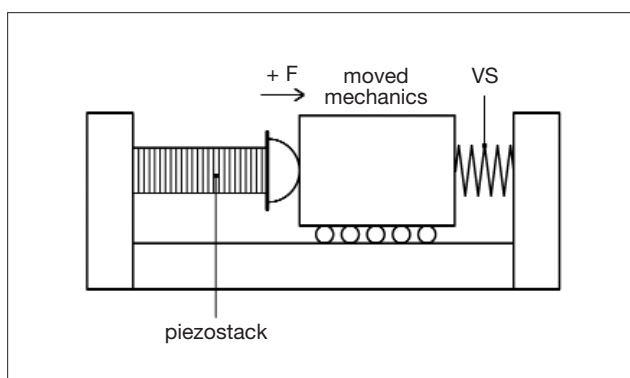

Fig. 4.10. **External preloading:**

The complete mechanics is pre-loaded by the spring VS towards the stack.

The whole arrangement is under permanent compressive load, no alternating force directions occur during cycling. Backlash is avoided.

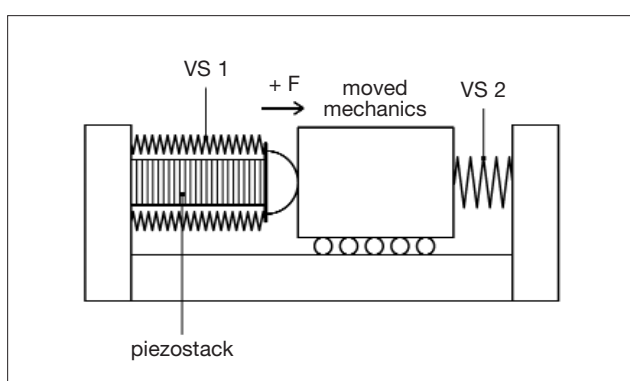

Fig. 4.11. **Split preloading:**

Two preload mechanisms are implemented:

- the individual preload of the stack (VS 1)
- the system's preload (VS 2).

This setup has advantages for piezo-mechanical systems with a high mass load:

The mechanical coupling between actuator and mechanics is only compressive.

Preload VS 2 can be kept low according the regular driving conditions.

Preload VS 1 acts as protection for the piezo stack for handling irregular high tensile forces (within the system).

In this case, actuator and mechanic parts can separate upon tensile stress.

VS 1 keeps the stack safe and sound.



4.9 Mechanical preloading (pre-stress)

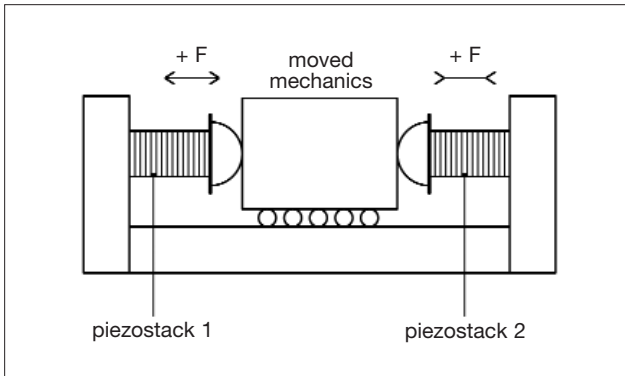

Fig. 4.12. **Active preloading/reset:**

Instead of the actuator-passive spring combination, two complementary acting piezo-actuators are used (differential drive).

The whole system is mounted into a mechanical support frame with high static stiffness.

Actively preloaded systems are by definition symmetrical push-/pull-systems. The static preload force level can be kept low even for high dynamics. Therefore, higher external payloads are acceptable. The advantages compared to passive resetting are:

- compensation of thermal drifts
- higher bandwidth

Even, when two actuators need to be powered, the overall power consumption can be kept low by using electronics with energy recuperation. Nevertheless, the total efforts for an actively preloaded system are higher than for simple conventional drive.

PIEZOMECHANIK actuators with integral preload

PIEZOMECHANIK offers all kinds of piezo stacks in a cased version with internal preload. The standard preload shows forces of about 10-20% of the maximum load. This design covers a very wide range of applications. Preloaded actuators with casings are much more rugged than the bare ceramic stacks and are more likely to withstand “rough” handling and operation, or the impact of other environmental influences.

On request, PIEZOMECHANIK provides actuators with increased preload levels up to symmetrically acting push-pull arrangements with regard to the force balance.

Dynamic operation of piezo stacks

5

The expression “dynamic operation” is used for operation modes where the actuator and the whole piezo-mechanical system are facing additional reactions compared to a nearly static driving situation. Most standard actuators are designed mainly for positioning with a slow shifting of components from position A to B. Dynamic operation adds effects like higher acceleration rates and forces superimposed on to the static force balances. The increased electrical power consumption results in self-heating of the actuator stack.

Application examples for high dynamic actuator excitation are: scanning, motion control, vibration generation, pulsed operation, fuel injection, shock generators and shakers. Piezo-actuators are mostly operated non-resonantly and can cover therefore a wide frequency range from DC up to > 10 kHz. This is in contrast to resonating systems like ultrasound generators. Those are operating continuously on a single high frequency > 20 kHz with large amplitude (=> 5.4/5.5).

5.1 Definitions

Dynamic operation has two aspects

- **Short-term effects relevant even for a single occurrence of excitation.**

The short-term time balance of a piezo activation deals mainly with acceleration effects and related forces. The achievable motion profile is also determined by the peak power capability of the power supply.

- **Examples:**

1. Pulsed operation (square wave excitation) of a piezo stack shows a huge short-term power level during the switching rise and fall. (Power levels up to the >> kW range).

On the other hand: when the repetition rate is very low (e.g. 1/sec), the average power is rather small.

- **Long-term effects related to permanent dynamic cycling.**

The long-term dynamic operation of a piezo-actuator defines the mean electrical power consumption of the system. This power is to be provided by the electronic supply.

Points of consideration are the self-heating of the piezoceramics and potential high cycle fatigue problems of the mechanical set-up.

2. For a periodic excitation profile (e.g. harmonic waves), the peak power and average power of the dynamic operation shows a fixed ratio.



5.2 Short-term excitation

The dynamic response of a piezo-actuator depends on how fast the actuator capacitance C is electrically charged

Actuator velocity $v \sim I = C \, dU/dt$

dU : variation of piezo voltage during charging

Actuator acceleration $dv/dt \sim dI/dt = \dot{I}$

dt : electrical charging time of capacitance C

(valid for the sub-resonant excitation of piezo stack)

■ **Example:**

A piezo-actuator with capacitance $C = 10 \, \mu\text{Farads}$ generates a displacement of $100 \, \mu\text{m}$ by a $0 \, \text{V}/+200 \, \text{V}$ excitation. Different charging times are considered

Charge time Δt :

100 msec 1 msec 100 μsec

Charge current $I \, \Delta Q/\Delta t$:

20 mA 2 Amperes 20 Amperes

Electric power $(1/2 \, CU^2)/\Delta t$:

2 Watt 200 Watt 2 KiloWatt

Acceleration (constant):

0,02 m/sec^2 200 m/sec^2 20.000 m/sec^2

The maximum displacement velocity by piezo ranges over a few m/sec (requiring highest acceleration levels)

Mechanical requirements:

Design rules for a piezo-mechanic setup to transfer dynamic motion efficiently

- low compliance of the attached mechanics
- the natural frequency of the mechanics shall be larger than twice the desired operation frequency
- sufficient durability of mechanical coupling elements to high-pressure levels (acceleration forces)

Preloaded actuators will be needed in all cases involving high dynamic excitation.

For extreme acceleration excitation (activation time $\ll 1 \, \text{msec}$), specially adapted actuator designs are needed beyond the standard techniques. Standard actuators will fail.

Electrical requirements:

An actuator's maximum velocity is defined by power supply's peak current.

An actuator's acceleration response depends on power supply's slew rate (band width).

If very high dynamic excitation with high peak power requirements is expected, switching amplifiers or high current 2-level switches are used (not linear amplifiers).

See PIEZOMECHANIK switching amplifiers RCV, High Voltage Switches: HVP.



5.3 Long-term operation

Prior to the analysis of long-term dynamic actuator operation, the short-term dynamics within the individual cycle need to be discussed (see chap. 5.2).

Mechanics:

High frequency mechanical cycling rapidly results in high cycle numbers and the question about structural durability of the whole piezo-mechanical system (e.g. material fatigue etc.).

To increase the reliability of such a construction, there must be a perfect match of its design to piezo-specific design rules. “Compromises” violating such design-rules will simply result in failures during long-term operation.

Electrics:

The average power consumption P_{av} of a cycled piezo-actuator can simply be derived from the charge/discharge rate (frequency) f and the energy content of the piezo-actuator applied per activation cycle.

$$P_{av} = \frac{1}{2} CU^2 f$$

U voltage level of charged actuator
C actuator’s capacitance

In a similar way, the mean (average) charging current \bar{I} can be determined

$$\bar{I} = Q f = CU f$$

Q electrical charge quantity contained in a powered stack

Notice: actuator’s stroke is proportional Q

Continuous wave harmonic sine-oscillation shows a fixed ratio $\bar{I}_{peak} : \bar{I}_{av} = \pi$.

Thermal aspects

During cycling piezoceramics, electrical energy is dissipated into heat due to “internal friction” of the moving piezoceramic structure.

Approx. 5 – 20% of the electrical energy input is converted into heat (fig. 5.1).

The loss mechanisms are rather complex and are not represented in a realistic way in the standard material data sheet for piezoceramics.

The heat generation depends to some extent on the mechanical operating conditions (stroke-force).

Blocked actuators show rather low losses, because

the “internal structure” of the ceramics cannot move, therefore no “structural friction” is present within the ceramics.

Further, the losses disappear nearly completely, when the piezoceramics are operated under cryogenic low temperature conditions. The ferroelectric nature of piezoceramics is “frozen” with the consequence of strongly reduced capacitance, strain and losses. Energy dissipation and self-heating are no concern.

Piezo stack’s temperature is defined by the equilibrium between heating power (energy dissipation) and applied cooling power (heat management).

Standard designed actuators for positioning do not contain explicit heat management measures. Power cycling can therefore only applied short-term until the stack has heated up to a distinct limit. High temperatures will reduce actuator performance and reliability.

PIEZOMECHANIK offers, for its cased actuators, the heat-management “thermo-stable” option for long-term power operation (=> chap. 6.1).

The temperature aspect can further be handled by using suitable PZT-ceramics with a wider operating temperature range.

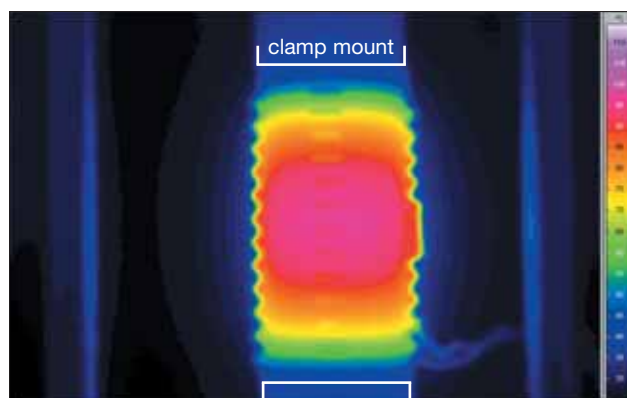

Fig. 5.1: Thermal image of a dynamically cycled high voltage actuator, clamped at its end faces. Environment: ambient air convection. Notice the cooling effect at the end-faces due to the clamping mechanics



5.4 Typical operating frequencies

A standard (incomplete) question is: what frequencies can be achieved by (non-resonant) piezo action?

The necessary counter-question is this: for what amplitudes? What other operating conditions?

Another typical misinterpretation of data sheet parameters is concerning the “resonance frequency”: The actuator cannot be operated up to this limit with full strain!

■ Example:

Self-heating and actuator dimensions

Different kinds of low voltage bulk and ring stacks (H)PSt 150 made of same PZT-material and layer-structure have been mounted with one side to a substrate, the other side is moving freely (fig. 5.2). The temperature of actuator’s top is monitored.

No special cooling means are applied (free air convection)

The elements are cycled @ 0 V/+150 V.

For technical reasons in most cases, the operating frequency needs to be kept well below resonance! The main limitation for the operation frequency is defined by the power consumption (frequency and amplitude!) and the self-heating of the actuator stack.

An actuator’s shape and volume/surface ratio rules the heat transfer rate as shown below.

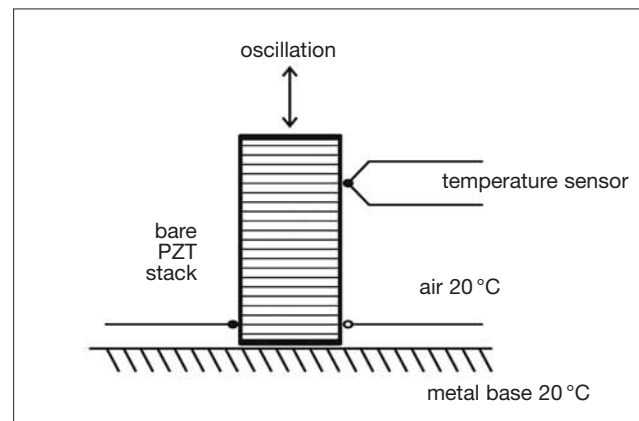

Fig. 5.2: Schematic test arrangement for the self-heating of different kinds of low voltage piezo stacks and rings

Actuator type	dimensions	equilibrium temperature @ 100 Hz	operating frequency for heat up to 80 °C
Bulk stacks			
PSt 150/2x3/20	2 x 3 x L = 18 mm	27 °C	1,300 Hz
PSt 150/5x5/20	5 x 5 x L = 18 mm	42 °C	340 Hz
PSt 150/10x10/20	10 x 10 x L = 18 mm	60 °C	160 Hz
Ring-stacks (hollow cylinders)			
HPSt 150/14-10/12	Ø14 x Ø10 x L = 13.5 mm	38 °C	440 Hz
HPSt 150/20-15/12	Ø20 x Ø15 x L = 13.5 mm	39 °C	430 Hz



5.4 Typical operating frequencies

It is easily seen that the self-heating phenomenon is less critical for ring type actuators and tiny stacks. The more bulky stacks are, the poorer is the heat transfer.

Notice:

Bulky stacks can show a remarkably higher temperatures in the ceramic's core than on the surface. A proper heat-management technique will allow an increase in frequency ranges (=> chap. 6.1). The achievable maximum amplitude oscillation frequency limits are in the range of several kilohertz range for small and medium sized elements.

Oscillations with reduced strain

Power consumption and self-heating depend not only on frequency, but also on the strain applied to the actuator.

When the piezo stack is operated at reduced voltage levels, they can run much higher frequencies. For a lot of applications, it is attractive to combine a high voltage actuator with a low voltage/high current power supply.

■ **Example:**

A ring-actuator HPSt 1000/15-8/20 VS 22 thermostable is combined with a large bandwidth amplifier LE 150/100 EBW a +/-2 μm oscillation can be generated up to about 10 kHz.

Ultrasonic oscillators can run very large amplitudes at high frequencies > 20 kHz.

What is their trick? They are using an enhancement-effect by mechanical resonance.

Hence, they can only run a single fixed frequency. A normal non-resonantly operated piezo-actuator needs to charge/discharge the complete electrical

energy content of the actuator from cycle to cycle to create a forced motion.

There is no mechanical energy-storing-mechanism from cycle to cycle within the actuator, when operated non-resonantly. Therefore a high electrical power is needed to drive the actuator resulting in correspondingly high losses => self-heating!

A good resonator like an ultrasonic device has a mechanical energy storing mechanism: the mechanical resonance.

With a rather low electrical energy transfer (low losses!), a huge mechanical oscillatory energy can be piled up over a distinct quantity of cycles. This results finally in a large oscillating amplitude.

How behaves a normal actuator at resonance:

The resonant accumulating effect is present to some extent, but it is much weaker than for an optimized ultrasonic device (up to 100 times smaller).

The background is the use of different kinds of piezoceramics used for actuators resp. ultrasound generation (=> chap. 8) due to the different application profiles.



5.5 Resonance

The shorter the stack is, the higher the natural frequency of a piezo stack's axis is. For piezo-chips with a length of a few millimeters it is $\gg 100$ kHz. Very long stacks for long strokes can show lower values in the kilohertz range. Natural frequencies and resonances describe an inherently oscillating system. The equivalent circuit diagram of a resonating piezo is therefore no longer a pure capacitor, but an oscillator circuit (capacitor + inductance).

Actuator based piezo-mechanical systems do not show only one natural frequency, but a variety of them with potential influence on the axial displacement (cross-talk).

For a lot of applications it is important that the piezo-actuator shift strictly follows the input signal. In the case of resonances, there is a phase-shift between the excitation signal and mechanical reaction remains.

- Piezo stacks with a high aspect ratio length/diameter show a bending mode with a lower natural frequency than the axial mode.
- Piezo elements also show natural frequencies of the stack's diameter. When the diameter is remarkably larger than the stack length, then the diameter resonance is lower than the axial mode.
- Common piezo-actuators for non-resonant operation are made from so-called soft piezoceramics with a high strain efficiency. This type of ceramic shows a rather high mechanical damping. Therefore, a piezo stack is a rather "bad" oscillator, expressed by a rather low quality factor. In the case of resonance, the resonant amplitude enhancement is typically < 10 (see fig. 5.3). In contrast to the broadband piezo-actuators, ultrasonic devices are a single frequency resonating system, using "hard" piezoceramics with very low mechanical damping (quality factor > 1.000)

- Any attached mechanics show natural frequencies that will be super-positioned with the original actuator motion. By using piezo-actuators, these resonances of the coupled mechanics can be excited or damped (motion control). Resonance excitation leads to large amplitudes with reduced power consumption. Resonant excitation of structures is used with miniature mechanics (MEMS, piezo motors).

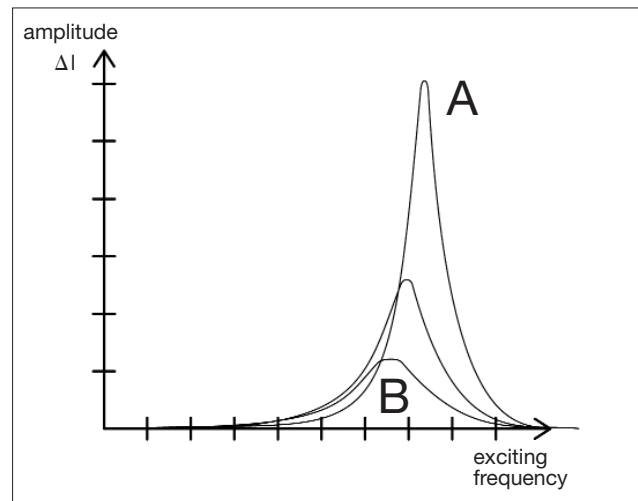

Fig. 5.3: Schematic of resonance behavior of oscillators with same natural frequency, but different damping. (A) Low damping, high quality factor: ultrasonic devices (B) High damping, low quality factor: soft PZT-actuators

Precision positioning set-ups with closed loop feedback control are usually operated well below the natural frequencies of a piezo-mechanical system to avoid feedback problems due to electro-mechanical phase shifting.



5.5 Resonance

Resonance frequencies are usually defined for actuators with one side fixed to a base and the other end freely moving. (Freely suspended

actuators with both sides free will show the double resonance frequency). The electrical excitation is usually based on low field variations.

When an external mass is added to a piezo-actuator, its resonance frequency will be reduced. The resonance frequency f_{A-M} of such an actuator-mass system can be estimated:

- the added mass M_{ext} is small compared to actuator's own mass M_A

$$f_{A-M} = f_{res} \frac{M_{eff}}{(M_{ex} + M_{eff})}$$

M_{eff} : effective mass of actuator $\sim 1/3 M_A$

- the added mass M_{ext} is significantly larger than the actuator mass \Rightarrow the simple spring/mass formula is valid

$$f_{A-M} = 1/2\pi (S_A/M_{ex})^{1/2}$$

S_A actuator stiffness
(spring rate = inverse compliance)

Magnifying mechanisms:

A motion magnified actuator hybrid system (factor n) shows a reduction of stiffness by a factor $1/n^2$ compared to actuator's original value. Resonance frequencies are therefore strongly reduced!

Catalogue data

The resonant response of a stack depends on mounting conditions (e.g. mechanical pre-stress). Variation of PZT-materials properties due to the manufacturing process have some impact on the electro-mechanical behavior of the ceramics.

Data sheet values and calculations show therefore pronounced tolerances.

The performance of piezo-actuators for various applications is not only defined by piezoceramics used. It depends on a lot of other features like the finish of the stack structure or other added features.

The most frequently requested actuator upgrades concern:

- improved heat management
- position sensing

PIEZOMECHANIK offers comprehensive assistance in all cases where special solutions are required to cope even with “exotic” piezo-actuator applications.

Ask the experts at PIEZOMECHANIK.

6.1 Heat management “Thermostable”

The dynamic charging power of a piezo-actuator is partially dissipated into heat. The actuator temperature reflects the equilibrium between heating by power dissipation and cooling by the heat transfer to the environment. Too high temperatures interfere with actuator performance and reliability.

Standard versions of piezo-actuators are primarily designed for low dynamic positioning tasks and are not provided with extra heat management features.

PIEZOMECHANIK offers the option “thermostable” to handle heat generation by dynamic operation. Heat is effectively removed from the ceramic stack and transferred towards the casing.

The “thermostable” casing is made from thermally high conductive metal (like copper, brass, aluminum etc.) providing effective heat sinking contact to the environment.

Just the simple mounting of a “thermostable” actuator to the operated mechanics provides a remarkable cooling effect.

For very high thermal loads, all common methods for enhanced cooling can be applied to the actuator casing like forced air cooling (incl. addition of air fins) or liquid cooling (fig. 6.1).

Notice:

The thermo-stable option does not alter actuators dimensions! Upgrading an existing standard based piezo-mechanical system with “thermostable” modified elements can be done in a straight forward

manner. Heat-management is recommended for all applications using power amplifiers like the LE or RCV-machines.

Example

A high voltage actuator PSt 1000/16/150 VS 25 with thermo-stable option + air fins + forced air cooling has been cycled dynamically with maximum stroke (150 μm) at about 800 Hz.

The casing-temperature was held at about 80 °C. The actuators ceramic core temperature was about 20° higher (measured via its electrical capacitance). A standard actuator of the same type without heat-management would reach its temperature limit at about 150 Hz.



Fig. 6.1: Various types of actuators with thermo-stable heat management Air fin corpus can be added



6.2 Temperature sensing

For distinct applications, it is useful to explicitly check the temperature of the ceramic stack. For temperature measurements, PIEZOMECHANIK provides options such as thermocouples or Pt 100/ Pt 1000-thermo resistors, mounted to the ceramic stack's surface.

Notice:

Information about the volume temperature of an actuator can be derived from electrical capacitance analysis (=> chap. 7, Operating instructions, => chap. 8, Material properties).

6.3 Low temperature operation

Piezoceramic stacks can be operated down to the lowest temperatures near absolute zero. Standard actuators run down to -40 °C. For operation at even lower temperatures, modifications may be necessary and are offered on request.

E.g. piezo stacks can be wired with poly-imide coated manganin-leads. Due to the reduced thermal conductivity of Manganin, the thermal loading of the cryo-station is then kept low.



6.4 Position sensing

A pre-requisite for ultra-precise positioning via closed-loop feedback control is the combination of the actuated system with a position sensor option. For position sensing, PIEZOMECHANIK offers high quality strain gages applied directly to the surface of the piezo stack. Usually, complete 4-active-grid-bridges are used to ensure temperature compensation and high sensitivity (Fig. 6.2-6.4).

By closed loop feedback controlled positioning, the non-linearity, hysteresis, and thermal drifting of a piezo stack are ruled out. Mechanically induced strain variations of the stack (e.g. by changes of the external load) are also detected and cancelled out.

Position resolution:

Strain gages can detect strain variations $\Delta L/L$ even below 10^{-6} .

Taking into account the actuator strain range of about 0.1 %, this motion can be resolved again to approx. 10^{-3} . For short stacks, position variations of 1nm magnitude can be detected.

For position sensing and control, PIEZOMECHANIK offers the strain gage amplifier DMS 01/03 and the complete feedback control system PosiCon.

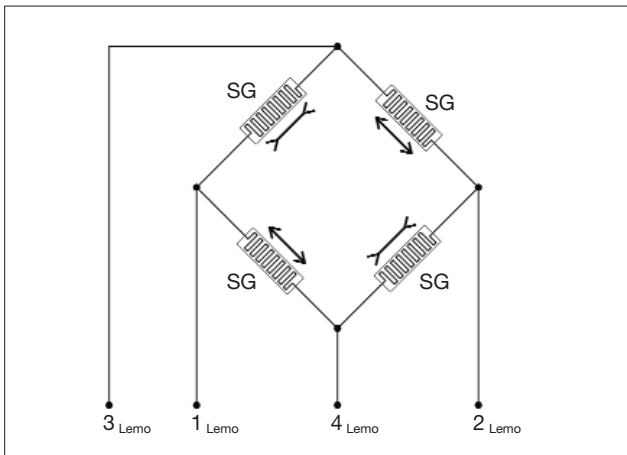

Fig. 6.2: Wheatstone-configuration with 4 active grids SG:
Supply voltage to 1, 2,
Sensor signal out on 3, 4

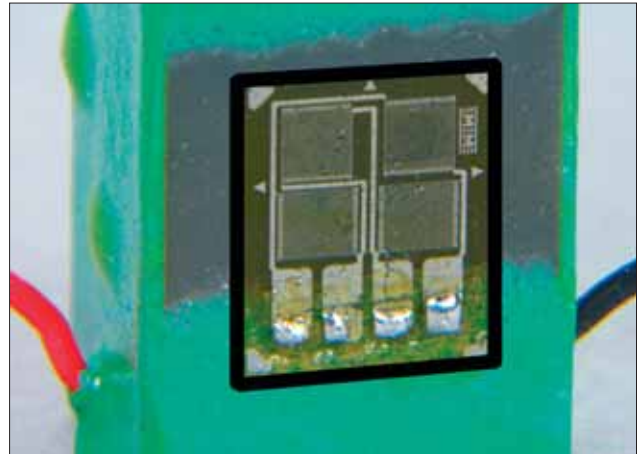

Fig. 6.3: 4-element strain gage-bridge configuration on a piezo stack
Typical gage resistance: 1.2 kiloOhms



Fig. 6.4: Basic position control equipment. Piezo-actuator with strain gage position sensor. Position read out by DMS 01 unit. Piezo-actuator supply electronics SVR 150 (left)



6.5 Further modifications

Enhanced mechanical preload

Depending on the individual application, higher mechanical preloading of the actuators may be needed beyond what is supplied as standard (about 10–20% of the max. load capability). For symmetric push-pull configurations or very high dynamic operation, preload levels up to 50 % will be necessary. PIEZOMECHANIK offers modifications of the preload mechanisms beyond standard.

Vacuum operation

PIEZOMECHANIK's standard actuators are generally vacuum compatible to standard laboratory high vacuum levels better 10^{-6} mbar. Neither the performance is impacted nor is vacuum contaminated by out gassing. In the case of a dynamic operation in vacuum, be aware of the lack of actuator cooling by ambient atmosphere.

For ultra high vacuum (UHV, up to 10^{-10} mbar range) applications, modifications to the actuators are needed, e.g. special coatings to avoid traces of contaminations. Bake out procedures can be applied to some extent. It is recommended to contact PIEZOMECHANIK in these cases to ensure the proper system results.

Rotating systems

Piezo-actuators are sometimes used in rotating mechanics. As long as the stack's axis show radial orientation, the centrifugal forces lead only to axial load variations for the stack without further problems.

Problems occur when the rotational axis and stack's axis are parallel and the stack shows a large aspect ratio length/diameter: The centrifugal force can lead to the bending or buckling of the stack. Special mechanical requirements are needed to handle this situation.

PIEZOMECHANIK is experienced in this field:
Ask for proposals.

Non-magnetic configurations

A special feature of piezo actuation is the complete absence of magnetic fields during motion generation. Accordingly, piezo-actuators are an ideal solution for applications where any kind of interaction with magnetic fields would cause problems. Piezo-actuators can be built up from completely non-magnetic materials including the casing, preload mechanisms, and wiring. On request, PIEZOMECHANIK supplies completely non-magnetic actuators.

Special materials

Piezo-actuators are excellent candidates for exotic driving conditions. Attention needs to be paid not only to the PZT ceramic itself, but to all other structural components of an actuator. PIEZOMECHANIK has experience in using a wide range of special materials like titanium, special alloys, INVAR, machinable ceramics, glass-or carbon-fiber based composites.

Operation instruction

7.1 Basic comment on actuator reliability

In most applications, piezo-actuators are usually kept as small as possible and operated nearly to their performance limits simply for cost reasons. As a result, in most mechanical designs, piezo-actuators become the “weakest link” from a mechanical point of view. In addition, ceramic is a material that is more complicated and more sensitive to issues resulting from improper handling than metal components.

Even when piezoceramic is “ruggedized” by placing it in a preloaded casing, a profound understanding of the technical background of piezo devices is a must to ensure high reliability through proper design and operation. Any step in handling, mounting and the operation of piezoceramic components must strictly avoid any single overload situation. Improper mechanical designs, irregular mechanical and incorrect electrical driving conditions need to be identified by realistic tests and evaluation procedures to come to a reliable solution!

“Mishandling” of piezo-actuators does not lead necessarily to the immediate break down, but reduces the long-term reliability with failure part way through the desired duty cycle. Piezo-actuators operated in a short-term manner can operate at or near their mode maximums, which would not be recommended, when long-term reliability and lifetime under long-term operation and large cycle numbers are a “must”. Vice versa, a short-term “successful” testing of a new set-up is not at all a signal for a long-term reliable solution.

Piezo-actuator reliability is subject to a wide range of influences from

- the attached mechanics
- the driving electronics
- the environment via the atmosphere or other media

Even when a piezo-actuated configuration has been proven for reliability, a seemingly “small modification” of the driving conditions may require a new re-evaluation of the system. In literature, usually two extreme cases are discussed for characterizing piezo-actuator reliability

- High cycle number reliability:

This criterion is mostly used for dynamic operations with elevated mechanical stress levels by short-term excitation.

 - **Example:** two-level switcher operation in pulse-width modulated processes, piezo fuel injectors with cycle numbers up to 10^{10} . Such high cycle numbers depend strongly on the quality of the mechanical design of the whole set-up!
- Long-term static operation:

Potential degradation is coming mostly from environment influences like excessive air humidity etc. in superposition with the piezo-mechanical driving parameters and temperature. When comparing specifications about reliability, pay attention to the applied driving conditions like the strain levels.

 - **Example:** humidity problems in tropical atmosphere can best be overcome by hermetic encapsulation of the stack.

In practice, a superposition of both kinds of operational profiles occurs. A simple extrapolation for reliability from the above stated general “experiences” will be limited in success. Individual testing under a realistic load duty cycle will be needed in any case to ensure high reliability of a piezo-mechanical system.



7.2 First check of a piezo-actuator

All kinds of piezo stacks show the following basic properties, when they are in a correct proper state:

- A piezoceramic stack shows electrically insulated end-faces allowing a floating potential operation. The electrical polarity of a stack is indicated by marking dots or color of the leads. Typically, the positive pole is indicated (e.g. by a red wire). The piezo stack expands when the voltage with correct polarity is increased. The polarity of an unknown actuator can be identified by applying a small voltage variation and checking the sign of the resulting shift! Alternatively, a stack can be connected to an oscilloscope. By application of a short squeeze, a small voltage pulse is generated. Its polarity shows the wire polarity (relative to ground).
- Piezo-actuators behave like electrical capacitors. Any related test e.g. by a RCL-meter must clearly indicate a capacitance value in the Nano or Microfarad range.
- Apply a DC-voltage to the stack and measure the charging current. After a while, this charging current will decrease to a negligible value below Microamperes. This reflects the very high internal resistance of the stack \gg Mega Ohms.

Note:

This internal DC-resistance has nothing to do with stack's power consumption or self-warming effects! When you identify lower resistance, please check all involved electrical parts, wiring, connectors, and plugs for failure, not only the stack. A failed stack with internal short-circuiting shows very low resistance of kilo Ohms or less.

- Testing of the overall electrical circuitry can be done acoustically by applying a harmonic signal of a few Volts to the piezo-actuator e.g. by a function generator. (Notice: discharge the piezo stack before connecting it to the signal source).
- A piezo-actuator shows the normal piezo-electrical effect (generator or sensor-effect). Connect the actuator to an oscilloscope and apply a small knock to your piezo-mechanics. A voltage response signal according the mechanical ringing of your piezo-mechanics will be found, containing information about natural frequencies of your arrangement.

Trouble shooting:

Stack failures are often assumed when the actuator creates a "strange noise". Keep in mind that the wrong electrical signals can be the reason for this behavior and the stack could be in good condition.

Rule:

Always check your complete electronic setup and related systems in all those cases where the actuator produces a "strange noise"!



7.3 Thumb rules

- Mechanical coupling and mounting of the ceramics is only allowed via stack's end-faces. Avoid mechanical contact to the side-faces. An air gap between actuator side-faces and the peripheral mechanics is needed, otherwise electrical insulation break down of the actuator surface may occur over time.

Piezo stacks show DC-insulation at the end-faces. When end-faces are made from poled piezoceramics, a very weak electrical AC-coupling during dynamic cycling can emerge. Set all metal mechanics electrically to ground.

- Apply only and purely compressive axial forces. No bending, torsion, or tensile forces should be present. The more "compromises" you allow on these points the worse the actuator's reliability will become.
- Keep the activation duty cycle of piezo-actuators as low as possible. No inverted operation by using high voltage levels as long-term basic state of your piezo action. No stand-by-operation: Switch off the actuator, when not in use or set the piezo signal to 0 V!

- To keep the long-term average voltage level low, use a longer stack and operate it with reduced strain. Use the semi-bipolar operation mode, if possible.

- Do not over-size the supply electronics with respect to voltage, current and power range. It is a fact of experience, that an accidental overload situation will emerge over time and damage the actuator.

- Be careful not to contaminate piezo stacks with chemical agents. Avoid traces of water, humidity, electrolytes (no touching with bare fingers), adhesives and casting materials generating corrosive agents during cure.

Cleaning can be done using 100% isopropyl-alcohol (propanole), avoid acetone.

Mounting faults:

Do not squeeze bare ceramic stacks sideways into tight-tolerance clearances.

Never apply knocks to accelerate mounting or to overcome mechanical resistances, otherwise you will permanently damage piezo-actuators in a very final way.



7.4 Handling and operation

The achievable performance and reliability of an actuator must be seen in context with the interaction with the operated mechanical system driving characteristics.

Poorly designed mechanics like low stiffness coupling to the actuator, friction, wrong preloading, wrong force coupling, misalignment of coupling faces from actuator to mechanics reduce significantly usable stroke, accuracy, force generation and make the use of piezo-actuator more or less worthless. Poor designing impacts actuator's long-term reliability.

Fig. 7.1 shows the consequences of inhomogeneous high force loading: A stack with excessive edge squeezing/pressure of the ceramic-stack by an improper force coupling. Cracks are generated within the active ceramic section resulting in electrical break down and arcing.

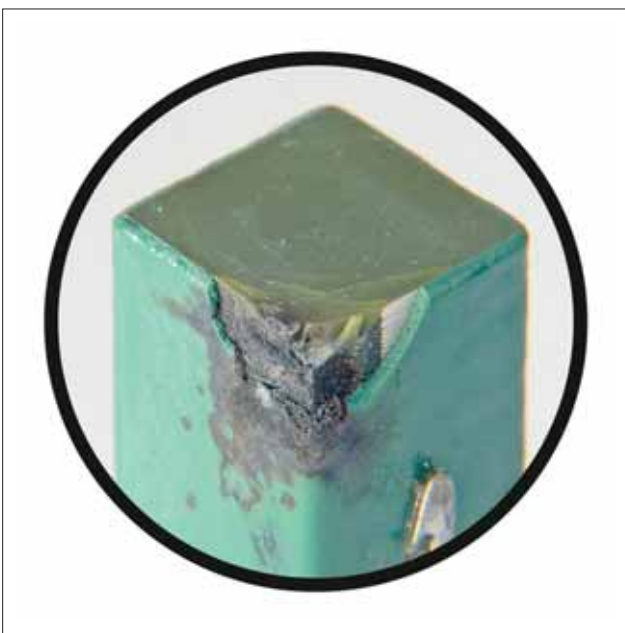

Fig. 7.1: Failed actuator stack, caused by a wrong coupling to the actuated mechanics. Local edge pressure exceeded ceramic's stability with subsequent electrical break down after approx. 800 hours.

Coupling of actuator and mechanics

Optimum actuation performance is achieved by following a few simple rules

- The coupling face of the mechanics shall cover completely actuator's end faces to achieve maximum force transfer (fig. 7.2). The contact force shall be homogeneously distributed over the contact area
- When a high load pressure is applied, the coupling faces of actuator and mechanics faces shall be absolutely plain (eg. by grinding) to avoid local overload of the ceramic front face.
- The resulting load force vector shall coincide with actuator's axis. Within a virtual cylinder of +/- 10% of actuator's cross-section (fig. 7.2) to avoid excessive bending and shear stress. Force misalignment tolerance becomes more critical for increased ratios actuator length/diameter. For high dynamic operation, actuator's axis shall further hit the centre of mass of the attached mechanics to avoid dynamic torque.

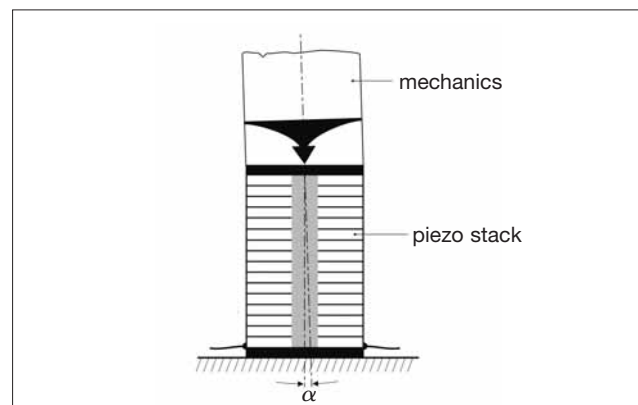

Fig. 7.2: Perfect plain-plain coupling of piezo stack and attached mechanics by floating axis orientation of the mechanics. Acceptable tolerance α : see above .



7.4 Handling and operating

- When the mechanical partner can readjust itself by a free suspension (floating axis) according to actuator's plane face, no problems will occur.
- Coupling of piezo-actuators to guided mechanisms (axis orientation not floating):
One of the most widespread design mistakes is coupling a plain-faced actuator directly to a plain-faced guided mechanism (fig. 7.3). Even the slightest misalignment between the orientations of the both plains leads immediately to edge squeezing with very high local spot pressures and subsequent ceramic damaging (fig. 7.1) especially under high force loaded conditions.

In a similar way, the plain-plain coupling of an axially acting stack with a rotating lever arrangement will lead to a fundamental edge squeezing situation in any case (fig. 7.4).

In the above cases, it is a must to decouple the axis orientations by using spherical / plain coupling or flex hinges or other means!

- The above requirements are valid at any time and any state of the system during set up and operation.

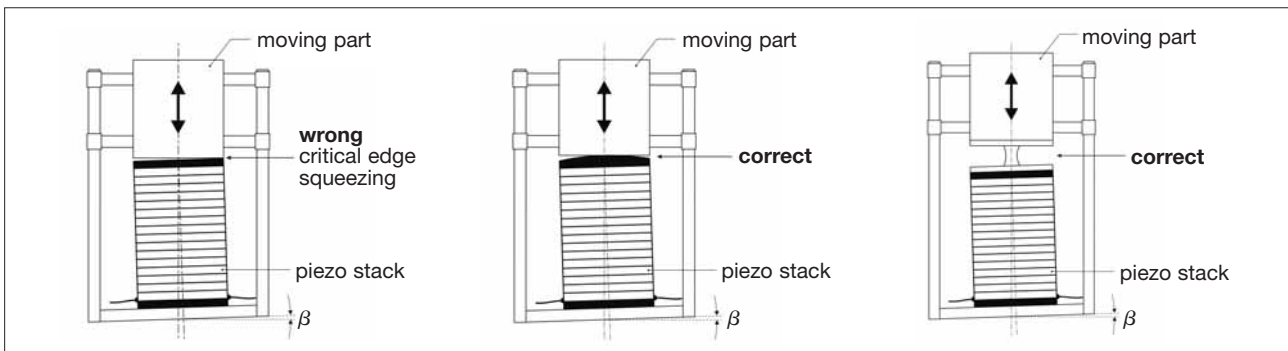

Fig. 7.3: In correct/correct coupling of linear guided mechanics

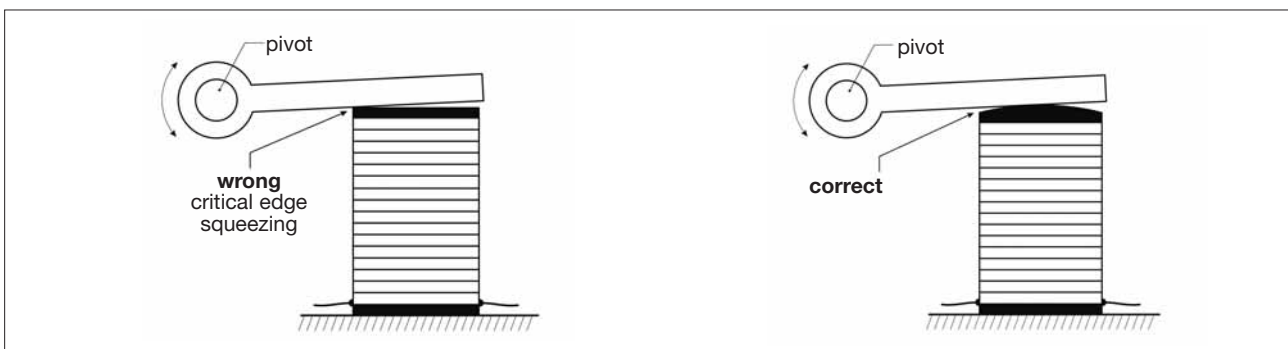

Fig. 7.4: Incorrect/correct coupling of a rotating mechanism



7.4 Handling and operating

Electrical aspects

The electrical controller performance determines the dynamics and motion characteristics of a piezo-actuated system.

Voltage ranges, polarity

The plus/positive -pole of a piezo-device is usually indicated by a dot or red wires. Typically, the coaxial cable shield electrically grounds piezo-actuator casings with coaxial cable. This configuration is preferentially used together with common voltage amplifiers.

On request, the cased versions can be built up with a floating potential setup: The stack actuator is insulated from the metal casing by separating electrical grounding from the casing. Floating potential wiring is most often used together with current control electronics. Ask PIEZOMECHANIK for details. Make certain to use the correct polarity when applying the specified maximum voltage, otherwise depoling or poling reversal of the ceramics will occur. This results in a useless irregular response of the actuator. Counter-voltages with lower levels can be used to some extent, but attention needs to be paid to the individual driving conditions (e.g. stack's temperature => 9.1).

Uni-polar activation

Voltage signals with the specified actuator-polarity can be applied to the piezo-actuator up to the specified maximum voltage ratings independently

Near-static long-term operation

When bare ceramic stacks are operated nearly statically in a highly humidity loaded atmosphere, it is not recommended to apply the maximum voltage U_{max} for long-term operation. Semi-bipolar activation can partially compensate for this reduction. Alternatively, the humidity-problem can be dealt with by using hermetically sealed elements. Metal-foil encapsulated stacks PSt 150/5x5/20 have withstood such conditions operating for 2 years (DC - operation) @ 150 V activation / 85% rel. humidity / 20 °C ambient temperature without any degradation (=> fig. 7.5). The humidity problem is strongly re-

duced, when the actuator is cycled dynamically. The elevated temperature due to self-warming repels the diffusion of water molecules into stack's surface.

Semi-bipolar activation

At room temperature, any piezo stack actuator can be operated up to a 20% counter-voltage ((-) $0.2 U_{max}$). Using the wider voltage range, stroke and force generation range of piezo-actuators are enhanced by at least 20% compared to the unipolar activation. PIEZOMECHANIK offers low power amplifiers SVR with semi-bipolar output. At higher temperatures, semi-bipolar operation shall only be applied to high Curie-temperature PZT-ceramics. Ask PIEZOMECHANIK for details.

Bipolar activation:

Successful counter-voltage operation of piezo stacks is influenced by stack's temperature (=> chap. 9.1). The stability of PZT-ceramics against unwanted de-poling effects increases dramatically at low temperatures. For very low (cryogenic) temperatures, the piezo stacks can be operated in a bipolar way within $\pm U_{max}$. By doubling the voltage range compared to the unipolar mode, the temperature-induced reduction of piezo-mechanical efficiency ($\mu\text{m}/\text{Volt}$) can partially be compensated for. PIEZOMECHANIK offers SVRbip amplifiers with bipolar high voltage output.

Example: Piezostacks PSt 150 can be operated with $\pm 150 \text{ V}$ at 77 °K (LN 2 temperature). The strain efficiency $\mu\text{m}/\text{V}$ is reduced down to 20%. Using bipolar activation, you get about 40% of the original unipolar stroke @ room temperature.



Fig. 7.5: Metal foil encapsulated stack



7.4 Handling and operating

Thermal aspects

● Heat management

The piezoceramic material properties depend on temperature e.g. the electrical parameters like capacitance and loss factor increase with temperature. Too high temperatures reduce performance and life-time.

Hence, the long-term power operation of piezo-actuators requires heat-management solutions for optimum power efficiency and lifetime.

PIEZOMECHANIK offers highly effective options for internal heat-management for standard piezo-actuators with a casing. The outer dimensions will not be changed!

(=> 6.1: option thermo-stable)

- Ring-actuators show a better heat-management balance than bulk stacks (=> chap. 5.4).
- Piezo stacks can be immersed in inert fluids for heat transfer (=> chap. 7.5).
- The de-poling stability of piezoceramics depends on temperature. Stay well within the safe area voltage range, when applying counter-voltages (=> chap. 9.1).
- Bulky stacks can show higher core temperatures. The thermal status of an actuator's volume can be determined by electrical capacitance measurements.

Maximum temperature limit

The Curie-temperature T_c is usually not the limiting factor with respect to actuator operation and storing conditions. In most cases, actuator temperature limits are usually significantly lower than T_c due to following effects:

- actuator's performance and operation data are worsening remarkably
- electrical losses/heat-dissipation increase with temperature
- the piezoceramics start to become electrically conductive (depends on type of PZT-ceramics)
- temperature limitations of used insulation-, contact- and coating materials

In practice, the typical operation temperature limits are about 2/3 of the ceramic's T_c .

Piezo-actuators adapted for high temperature can be operated up to 150 °C long-term (200 °C short-term):

HS/HT PZT-material based components (=> chap. 8).

■ Comment:

A special case are low T_c -ceramic based stacks: They can be stored even at high temperatures. Potential depoling is compensated for by the first full voltage swing operation at normal temperature levels. The ceramic is repoled = reactivated then. (useful for out-bake @ UHV)



7.4 Handling and operating

Low temperature conditions

PIEZOMECHANIK standard stacks can be stored and operated down to low temperatures of $-40\text{ }^{\circ}\text{C}$. The actuator parameters show following trend for decreasing temperatures:

- reduction of strain/Volt
- reduction of hysteresis and non-linearity
- reduction of electrical capacitance
- reduction of loss factor
- increase of electrical stability against de-poling (allows bipolar operation)

Pay attention to the overall thermal expansion behavior of your mechanical frame work, when applying large temperature variations. Avoid mechanical overload due to thermally induced stress during cool down.

Notice:

The warming up of a cold piezo-actuator needs occur slowly. The risk is the condensation of water on the actuator resp. the sucking of humidity inside the casing. The ceramic core shall show even a slightly higher temperature than ambient (use a simple heater). Check stack's volume temperature via the electrical capacitance.

Lowest temperature (cryogenic) operation

Piezoceramic stacks can be stored and operated under LN₂ or LHe conditions near absolute zero if they have been adapted properly. Care is needed for setting up a suitable internal actuator structure to handle thermally induced stress during cool down. Points of attention are the thermal conductivities, thermal capacitances and different coefficients of thermal expansion for the different materials in use (PZT-ceramic, metal electrodes, coatings). Ask PIEZOMECHANIK for details on cryo-compatible actuators.

For low temperature operation, preloading shall be applied to the stacks. The mechanical coupling is best done by compressive means only (\Rightarrow chap. 4.9) to avoid any external tensile stress. At cryo-temperatures, PZT-ceramic shows very high coercive fields. Bipolar voltage operation can be applied.



7.5 Adhesives – Electrical contacts – Chemistry

Piezo-actuators have electrodes and high electrical fields in the vicinity of the ceramic stack's surface. It is easily understood that any mechanical or chemical impact on this surface structure results in a high risk of failure.

- Be careful with any contaminations of actuator surfaces with unknown species. Even traces of corrosive agents will result in an actuator failure over time. Do not touch ceramic elements with bare fingers. Avoid contact of the ceramics with water containing fluid or electrolytes.
- Be careful, when using adhesives, sealing and encapsulation materials: no corrosive reaction

- Glue line quality: At first glance, a very thin and hard glue-line gives the best coupling quality in terms of rigid coupling of the involved components.

Attention:

Large coupling cross sections, together with hard and inflexible glue lines: The lateral d_{31} motion of the piezo-component will be hindered and consequently the axial d_{33} response too. High mechanical stress is produced within this composite structure during piezo activation (=> fig. 7.6/7.7).

When large area gluing is to be done, preliminary tests must be used to find the optimum adhesive formula and glue-line thickness to ensure unhindered motion.

products must be generated by the cure processes. Do not use standard 1-component silicone compounds: they generate traces of acids, when reacting with air humidity. These agents will penetrate into actuator's surface and start electro-corrosion. Use corrosion free materials only!

- Usually adhesives like epoxies, poly-urethanes, or cyano-acrylates are successfully used. Best glue line quality is achieved for longer cure-times > 30 min at room temperature or mild heat up. Rapid cure creates mechanical stress and poor glue line quality.

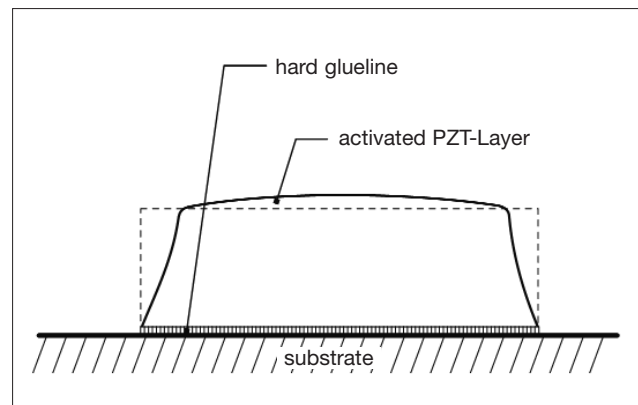

Fig. 7.6: Lateral (in-plane) clamping effect by large area hard gluing a piezo-chip on a rigid substrate. The thickness expansion of the PZT-layer is blocked also, distortions occur in the ceramic (tilting, reduced stroke)

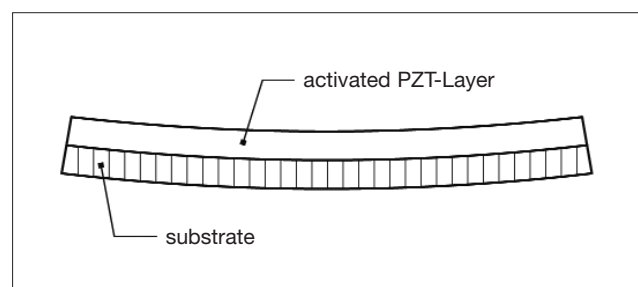

Fig. 7.7: Bending structure of a thin substrate/piezo-layer composite by hard adhesive coupling. Deformation of optical flats can occur.



7.5 Adhesives – Electrical contacts – Chemistry

Useful Materials

- **Temporary bonding**

Bonding waxes as used for wafer grinding, melting point 70 °C, Logitech Polishing & Lapping, Glasgow

- **Permanent bonding**

for -50 °C to +120 °C temperature range
High quality epoxies: EpoTec, Araldite, longer cure > 30 min at room temperature or slightly elevated temperatures.

- **Low outgas and cryo-compatible glue lines**

Stycast 2850 FT
TorrSeal

- **Provisional bonding**

Cyano - acrylates: give thick and flexible glue-lines, not recommended for long-term use

- **Casting, sealing**

e.g. 2-component silicone rubbers RTV2
non-corrosive 1 component RTV silicone or acrylate – based rubber

- **Liquids for cleaning and cooling**

General requirements:

Absolutely no water content, even traces
No electrolytes, non-ionic liquids only
Test for compatibility with polymer coatings!
Paraffin oil, silicone-oils, hydrocarbons (fuel), transformer oil, alcohols have successfully been used e.g. for cooling.

Use 100% isopropyl alcohol (iso-propanol, IPA) for cleaning: Avoid acetone and other ketones

- **Electrical contacting**

Most multilayer piezo components from PIEZOMECHANIK have electrical wiring. Nevertheless it is helpful to understand how to apply electrical contacts to PZT-components, having no wires. Such piezo-elements have very thin metal-layers as electrical contacts (thickness μm).

These metal layers can be electrically contacted by soldering, conductive adhesives and coatings or elastic spring contacts. Be careful: accidental removal of these original contact layers make the piezo component unusable.

Soldering of PZT-metalization

Attention: Improper soldering dissolves the thin metalization in the solder tin making an electrical contacting then impossible.

- *use standard solder tin*
- *use a tiny solder tip for setting small solder*
- *set solder tip 300 ° - 350 °C*
- *keep solder melting time on metalized ceramic rather short (max. a few seconds should be sufficient)*
- *use non-corrosive solder flux , remove residues*



7.6 Further aspects

Environmental influences

Piezo-actuators have electrodes and high electrical fields in the vicinity of the ceramic stack's surface. Any mechanical or chemical impact on this surface structure results in a high risk of failure. One main concern is the operation of piezo-actuators within very humid and polluted atmospheres (aerosols, like tropical ambient air). This situation can be overcome by reducing the operating voltage level of piezo-actuators or hermetic encapsulation (=> fig. 7.5).

Vacuum operation

PIEZOMECHANIK stack actuators are compatible with high vacuum conditions. Restrictions occur in the fine vacuum in the mbar range. Especially high voltage actuators can ignite glow discharge on their surface, when a distinct voltage level is exceeded. This does not allow a regular operation of these actuators with maximum voltage ratings. Low voltage actuators do not show the glow discharge problem and can be used regularly.

Noble gases, hydrogen atmospheres

Hydrogen and light noble gases like helium interfere with the electrical insulation conditions of a piezo stack. The accepted maximum driving voltage is reduced. Insulation performance breaks down. Individual tests are necessary to determine stable operating conditions.

Radiation

Piezo-actuators are sometimes exposed to high energy radiation or neutron fluxes (e.g. resonator tuning in synchrotrons or accelerators for spallation neutron sources). The heavy-metal containing piezo-ceramics is not degraded by radiation.

Space-borne applications

Piezo stacks are compatible with vacuum, cryo-conditions and radiation. Therefore they are well-suited for space applications. Adoption to special aspects of a mission can be implemented into an actuator design on request.

Common piezo-actuators use no “quartz” or “single crystals”, but a simple oxide ceramic made from PZT (Pb lead, Zr zirconium, Ti titanium). This compound class shows much better piezo-electrical and piezo-mechanical efficiency than quartz.

The PZT- formulation can be varied with regard to stoichiometry and dopants resulting in a broad spectrum of material properties optimized for different application profiles.

Not all desirable properties can be put into one compound. Piezo-mechanics is to some extent the “art of best compromises”, when selecting a suitable material for a distinct application.

Piezoceramics is a ferro-electric compound. This means, that the electro-mechanical conversion process for producing a motion is related to a kind of self-enhancement process based on an internal reorganization of the material’s structure.

- This self-enhancement process results in the higher piezo-electrical efficiency of PZT compared to materials like quartz.
- The structural re-organization is accompanied by “internal structural friction”, resulting in energy-losses. When the structural re-organization is hindered by blocking conditions or very low temperature, these losses are reduced.

Notice:

PIEZOMECHANIK is using piezo-electrically “soft” and “semi-hard” PZT-formulations. High strain rates and high energy contents are achieved for efficient non-resonant electro-mechanical conversion.

Developing new piezo-materials is a steadily ongoing process in the ceramic industry.

PZT is the most widely used smart material for solid-state actuation. Alternative materials with enhanced strain capability are under study, but all these “innovative” materials have severe drawbacks regarding common driving conditions in practice.

- This ferro-electric structural re-organization of PZT shows nonlinearities
 - ➔ hysteresis in stroke/voltage diagram, capacitance varying with driving conditions
 - ➔ complex elastic behavior (compliance and force balances depend on the degree of structural variation).
A moving structure is “softer” than a static one (see blocking force experiment 4.5 in comparison to the classical compression experiment 4.6).
Literature tries to down-size this complexity by linear approximations, but to the cost of consistencies between theory and practice.

PZT ceramics’ material data are usually defined at low field excitation where nonlinearities are not dominant. In practice, high electrical fields are applied to PZT actuators, resulting in a non-linear enhanced response (“ferro-effects”) and altered parameters. Nevertheless, for reasons of comparison with materials from different suppliers, the classical characterizations are used for describing actuator ceramics and shown in the tables. The data shown in the tables are valid for room temperature operation.



8 Properties of piezoceramics

Piezoceramic for stacks PSt 150

The PSt 150 stacks are a kind of “general purpose” actuator e.g. for low and medium dynamic positioning tasks.

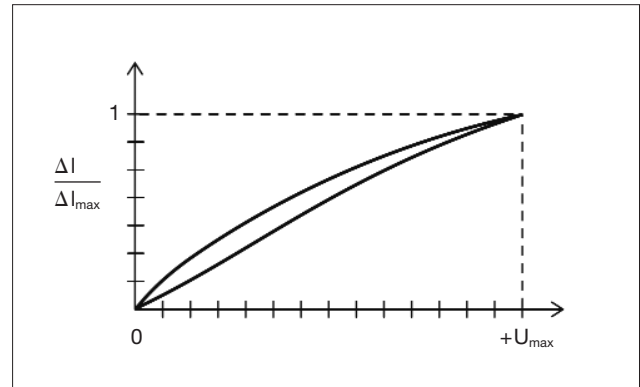

Fig. 8.1: Schematic stroke-/voltage diagram for high field excitation of PSt 150 stack actuators.

Piezoceramic HS/HT for low voltage actuators PSt-HD 200, piezo-chips (H) PCh 150, standard high voltage actuators (H)PSt 500 and 1000

The HS/HT-piezoceramic is used as standard material for high voltage actuators. It is a high strain material with a wide temperature range up to 150 °C. The actuator data do not vary strongly with temperature. This type of material is used for piezo-fuel injectors.

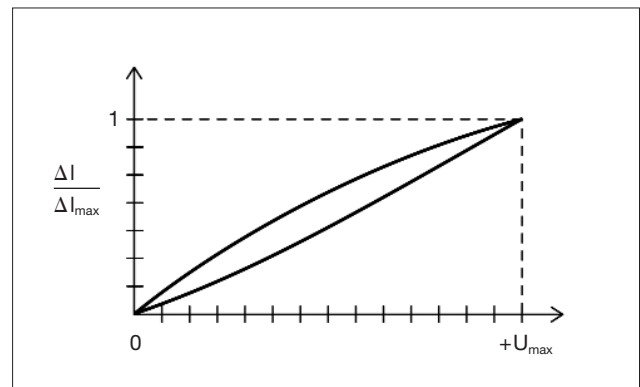

Fig. 8.2: Schematic stroke-/voltage diagram for high field excitation of HS/HT-piezoceramic.

Piezoceramic HP with highest mechanical power density for high voltage actuators (H)PSt 500 and 1000

Higher strain rates and blocking forces are achieved compared to the standard PZT material HS/HT. Depending on the individual application conditions, the useable mechanical energy output density is doubled. This type of material is preferred for motion control, active structures, and high-pressure hydraulic pumps. The Curie-temperature is lower than for the HS/HT composition. For high energy conversion rates, an efficient heat management solution is needed.

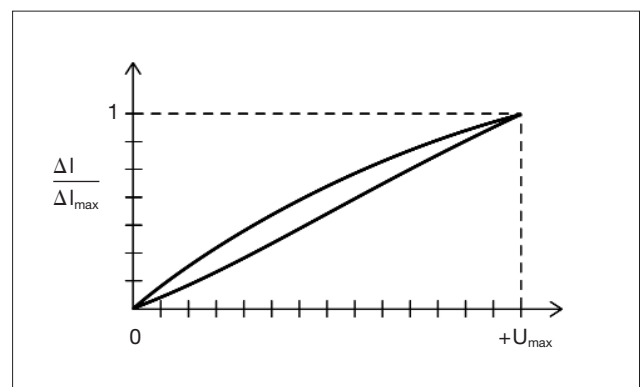

Fig. 8.3: Schematic stroke-/voltage diagram for high field excitation of HP-piezoceramic.



8 Properties of piezoceramics

Piezo-mechanical data (small signal-values at room temperature)

	PSt 150 Stacks	PZT HS/HT	PZT HP
ϵ_{rel}	5,400	1,850	3,800
loss factor (10^{-4})	200	130	160
coupling factors			
K_p	0.62	0.62	0.65
K_{31}	0.34	0.34	0.38
K_{33}	0.68	0.72	0.74
Piezoelectric charge coefficients (picometer/Volt)			
d_{31}	-290	-190	-275
d_{33}	635	440	680
Elast.compliance (10^{-12} m ² /N)			
S_{11}^E	14.8	18.5	15.8
S_{33}^E	18.1	20.7	23
Frequency constants (m/sec)			
Radial	2,040	2,020	1,960
Thickness	1,800	2,030	1,885
Transverse	1,410	1,325	1,420
Longitudinal	1,370	1,250	1,190
Quality factor (resonance)	70	80	80
density (g/cm ³)	8	7.74	7.83
Curie-temperature °C	150	340	215
Spec. heat Ws/°K kg	380	380	380
Thermal conductivity Ws/m K (axial)	ca. 1.5	ca. 1.5	ca. 1.5

Non-linearity:

Due the ferroelectric nature of PZT-ceramics, the above-mentioned parameters can vary significantly with the operating electrical field strength. In practice, PZT-ceramics are operated with large field excitation levels for actuation.

The following example for the rather stable PZT-ceramics HS/HT illustrates this trend:

	small signal ($E \ll 100$ V/mm)	large signal 2 kV/mm
ϵ	1,850	3,500
d_{31} (picometer/Volt)	-190	-270
d_{33} (picometer/Volt)	440	640
elast. modulus $_{33}$ (10^9 N/m ²)	65	30



8 Properties of piezoceramics

Temperature effects

Electrical capacitance:

The relative dielectric constant ϵ of piezoceramics varies noticeably with temperature. It is not unusual for an actuator's capacitance to increase by approximately 40% when heated up from room temperature to 80 °C. This effect has to be taken into account when selecting a proper amplifier for dynamic operation (\Rightarrow chap. 9.3).

It is immediately understood that, for power efficiency reasons in the case of a dynamic operation, a proper heat-management option is recommended to keep the actuator temperature low.

Thermal expansion of piezo stacks

Piezoceramic is also characterized by an anisotropy in thermally induced expansion.

The CTE (coefficient of thermal expansion) α for PZT-ceramic is

- approx. -5 ppm/°C in poling direction
- approx. +5 ppm/°C in lateral direction

(measured with short-circuited electrodes)

Low voltage stacks

(temperature range -40 °C thru +120 °C)

Axial α : approx. - 5 ppm (neg. coefficient!)

High voltage stacks

Axial α : 0 to + 2 ppm/°C

High voltage piezo stacks are a composite structure made of piezoceramics and metal foil electrodes. Hence HV actuators show a CTE differing from pure PZT-ceramics.

PIEZOMECHANIK high voltage stacks show rather low CTEs when compared to similar products of other suppliers.

Notice: Metal end-pieces applied to piezoceramic stacks contribute to the over-all thermal expansion of such a device. A piezo-actuator's casing is usually not involved in the thermal expansion balance, when the mounting of the actuator is done via its end pieces.

If an actuator is fixed using the casing tube, this situation changes: e.g. by clamping the casing or using piezo cartridges FPSt with front thread mounting. The thermal expansion of the complete force path needs to be taken into account.

Piezo strain

The achievable strain/Volt of a piezo-actuator is represented by the d_{33} -coefficient (piezo-electric charge constant) in the data sheet.

Compared to room temperature operation,

- the strain/Volt efficiency decreases remarkably, when temperature is decreased.
At cryo-temperatures, the ferroelectric self-enhancement of the piezoceramic reaction is strongly reduced.
- the effect of an increase of temperature on the d_{33} parameter depends on the Curie-temperature of the PZT-material used.
Soft-PZT-based PSt stacks show a slight efficiency reduction, when heated up to 80 °C:
A stack PSt 150/5x5/20 operated @ 0 V/+150 V shows a shift of
20 μm @ room-temperature,
19 μm @ 80 °C

High Curie temperature material HS/HT experiences an efficiency increase of about 5%, when heated up to 100 °C.

Pyro-electricity

Piezoceramic is electrically self-charging, when a temperature variation is applied.

This effect is irrelevant for actuation, although the effect can electrically shock the user when a charged actuator is touched with bare hands at the leads.



8 Properties of piezoceramics

Comparison between actuator and ultrasonic PZT-ceramics

Ultrasonic techniques are a kind of resonant actuation, where the device is designed to run at permanent (cw continuous wave) harmonic oscillation on a high single (resonance) frequency with large amplitudes. The achieved large amplitudes are the consequence of resonant amplification over a large number of cycles. The efficiency of storing mechanical oscillation energy is described by the “quality factor Q”. A high Q indicates a low mechanical damping.

Usually a “normal” piezo-actuator is operated “non-resonantly” broadband from DC up to rather high frequencies. Large amplitudes shall be generated within one cycle. Such an operation profile is only available for the class of “soft” or semi-hard PZT-materials. These materials shall show a larger piezoelectric coefficient d_{33} and an elevated dielectric constant. Actuator ceramics show a low quality factor Q: common broadband piezo-actuators are rather “poor” oscillators (\Rightarrow 5.5, Resonances).

Parameter	ultrasonic hard PZT	actuator soft PZT HP
Quality factor Q	> 1,000	70
Piezo electric charge constant d_{33} (picometer/Volt)	240	680
rel. dielectr. constant ϵ	1,000	3,800
Curie temperature T_c °C	310	215

Single frequency ultrasonic resonator systems show strongly reduced losses and heat dissipation (in relation to oscillation power; frequency, amplitude) compared to broad band actuators.

Electrostrictors

Electrostrictive ceramics can roughly be described as a kind of piezoceramics operated at its Curie-temperature near the phase transition piezoelectric-paraelectric .

A special class is the PMN-PT solid solution ceramics (lead-magnesium niobate in lead-titanate) shows a Curie-temperature around room temperature.

A stack, built up from this electro-strictive material shows the following performance:

- axial strain : up to 0.1 %
- hysteresis 1 – 2%
- no long-term drift upon application of a voltage step

Therefore, electro-strictive actuators have a few advantages in open loop positioning compared to PZT-actuators. Nevertheless, when a very high accuracy is demanded or external influences need to be compensated for, the electrostrictors require closed loop feedback control like PZT-actuators. Additionally, the above stated performance data are only valid in a rather narrow temperature range of about ± 5 °C around the optimum point. Therefore, dynamic operation is ruled out because of the self-warming problems. Summing up these side conditions, electrostrictive ceramics are not commonly used.

Electrical powering of piezo-actuators

9

For actuation, electrical energy is converted into a mechanical reaction. The energy content E of any actuator depends only on the active piezoceramic volume and the applied electrical field strength.

Expressed in usual electrical terms, the energy content E is

$$E = \frac{1}{2} CU^2$$

Newcomers to piezo actuation ask for actuators with very low capacitances to save energy or power in a very general way. Keep in mind, that energy conservation is valid for piezomechanics too. High power mechanical output cannot be achieved with a low electrical input.

The electrical parameter “capacitance” is responsi-

ble for the energy coupling on the electrical side. Accordingly, it cannot be minimized in an arbitrary way.

Further, capacitance itself is not an absolute measure for the power consumption. As mentioned before, it depends further on the applied voltage levels. Therefore it is self-evident that high-voltage and low-voltage actuators show very different nominal capacitance values for the same energy and power balances.

9.1 Electrical input and piezo-mechanical reaction

The electrical power supply defines, to a large extent, the performance of a piezo-actuated system.

Careful selection of properly adapted electronics is therefore a must.

Electrical noise

One of the unique features of piezo actuation is the conversion of a small precise electrical signal into an equivalently small shift in position. Consequently, any undesired electrical signal variation like noise or other instabilities is transformed into an equivalent “mechanical” noise or uncertainty of position too. It has been found, that the positioning accuracy of a piezo-mechanical system is not limited by the piezo-actuator itself, but by the quality of the electronics. Ultra-fine positioning needs therefore a high quality power supply with regard to the signal/noise (S/N) ratio.

The position noise Δl_{noise} can be estimated by

$$\Delta l_{\text{noise}} = \Delta U_{\text{noise}} \times (\Delta l_{\text{max}} / U_{\text{max}})$$

Δl_{max} : max.actuator stroke at maximum voltage U_{max}
 ΔU_{noise} : voltage noise

The lowest noise levels are achieved by low power analogue linear amplifiers.

High power switching amplifiers show higher noise levels and are mainly used for dynamic motion control.

PIEZOMECHANIK offers low noise amplifiers SVR for highly sensitive positioning tasks.

■ Example

The low noise amplifier SVR 150 shows a noise level of about 0,3 mV_{pp}

Combined with a piezo stack PSt 150/7/20 VS 12 (stroke 20 μm @ 0 V/150 V) the equivalent nominal uncertainty in position is 0.04 nanometers.

Because the voltage modulation by noise represents a “small-signal excitation”, the real fluctuation in position is << 1 Angstrom.



9.1 Electrical input and piezo-mechanical reaction

Pulsed operation

The mechanical response/rise time of a piezo stack is determined by the charging time of the actuator's capacitance. The higher the charging current is, the faster the actuator reacts.

To get a shift in position equivalent to a voltage variation $dU(t)$ with a rise-time dt , an actual current $I_a(t)$ is needed according to:

$$I_a(t) = C \, dU(t)/dt \quad C \text{ actuator's capacitance}$$

The maximum rating of $I_a(t)$ is the needed peak current I_{peak} to be delivered by the power supply. The peak-currents I_{peak} for the most common signal profiles are shown below:

Sine: $I_{peak} = \pi C U_{pp} f$
Triangle: $I_{peak} = C U_{pp} f$
Square wave: $I_{peak} = C U_{pp}/dt$

U_{pp} total voltage swing $dU = U_{pp}$.
 dt voltage rise-time

Pulse-generators

Distinct applications with a fast 2-level excitation will not need a steadily signal-varying amplifier. For a simple pulse-width modulation of a valve with simple "open" and "close" levels, an electrical switch will do the job. Keep in mind, that "big block" actuators show large capacitances and need therefore high charging current (up to the order of magnitude of 100 Amperes).

For very short rise-times, the necessary peak currents can reach significantly high levels.

Example

A piezo-actuator with 5µFarad capacitance shall be charged within a time dt_c with a voltage step U_{pp} : 0 V/150 V

$$dt_c = 100 \text{ msec} \Rightarrow I_{peak} = 7,5 \text{ mA}$$

low dynamic positioning eg. by an amplifier SVR 150

$$dt_c = 1 \text{ msec} \Rightarrow I_{peak} = 750 \text{ mA}$$

dynamic motion control, power level of a LE 150/100 EBW amplifier

$$dt_c = 150 \text{ µsec} \Rightarrow I_{peak} = 5 \text{ A}$$

piezo fuel injectors ,use power switches like HVP

$$dt_c = 10 \text{ µsec} \Rightarrow I_{peak} = 75 \text{ A}$$

piezo shock generation using HVP switches

For rise times < 1 msec, piezo-actuators need to be adapted to the very high electrical and mechanical load conditions. Standard actuators will fail (see chap. 4.9: mech. preloads).

For such purposes, high power "on/off"-switches are used for efficiency and cost reasons. Ask PIEZOMECHANIK for HVP switches and its derivatives for shock generation.

Pulsed operation requires care adaptation of the actuator configuration to prevent mechanical damage of stack's structure. Standard actuators will fail!



9.1 Electrical input and piezo-mechanical reaction

Long-term average current

For long-term cycling operation of a piezo-actuator with a distinct frequency f and a voltage variation ΔU , the actuator's capacitance C is charged/discharged accordingly.

This defines an average charging current \bar{I} according to:

$$\bar{I} = C \Delta U f$$

To produce a permanent cycling of a distinct signal function, the power electronics shall be selected for both current ratings: the short-term peak current and the long-term average current.

For a periodic signal, peak and average current will have a fixed ratio.

Examples:

harmonic cycling $I_{\text{peak}} / \bar{I} = \pi$
triangle $I_{\text{peak}} / \bar{I} = 1$

Power amplifiers from PIEZOMECHANIK are mostly designed for a $I_{\text{peak}} : \bar{I} = 3$ to allow a well matched cw high dynamic cycling e.g. for motion control applications.

Notice:

a noticeable fraction of the electrical charging power is reactive. It is redirected into the amplifier during discharge. The standard linear amplifiers will convert this power into heat internally, so that the total energy per cycle is finally consumed. A more power efficient alternative are amplifiers with energy recycling (energy recuperation):

Energy-/power-balances

The energy content E of a piezo-actuator is $E = \frac{1}{2} CU^2$, when charged up to a voltage U . The electrical energy input during actuator's charging is split into

- Mechanical work (displacement, elastic deformation) (\Rightarrow chap. 4.2).
- Dissipation losses = self-heating rate about 5-20% depends on detailed mechanical driving conditions
- Non-converted electrical rest energy: is stored in actuator until discharge

Average electrical power consumption

When the actuator with an energy content E is cycled with a frequency f , an average electrical charging power P is needed according to:

$$P = E f$$

■ Example:

A 10 μ Farads actuator is charged @ 0 V/100 V with 100 Hz \Rightarrow average charging power: 5 Watts.

The reactive part of the input electrical energy, when fed back to the amplifier, can be reused for the next charging cycle. Switcher-type amplifiers can be designed for energy recovery like PIEZOMECHANIK's RCV amplifiers.

Only this kind of strategy allows a non-resonant actuator to cycle with high power levels with acceptable efforts.



9.1 Electrical input and piezo-mechanical reaction

Voltage ranges, voltage polarity

The classical actuator activation was done by using unipolar voltage signal $0/U_{\max}$ according the actuator's specified voltage polarity and operating range. This kind of operation can be applied under all specified operating side conditions e.g. temperature range. On the other hand, it has been experienced, that under distinct conditions a semi-bipolar or bipolar signal can be put into a piezo stack, enhancing its displacement and force range.

The point of attention is the de-poling stability of PZT-ceramic, expressed by the so-called "coercive field strength". This de-poling threshold depends strongly on ceramic's temperature. A piezo-actuator can be operated with a counter-polar voltage, as long as this level keeps the corresponding electrical field well below the coercive field E_{depol} (fig. 9.1).

Notice:

the above mentioned aspects are valid for all kinds of piezoceramic components like bimorph benders or shear-elements

Generally, three operation modes can be distinguished according the operating temperature:

Unipolar activation: can be applied over the complete operating temperature range.

Semi-bipolar operation: for room temperature or lower.

Bipolar operation: with max. voltage ratings only applicable at very low temperatures.

The wider the voltage swing is, the larger the displacement and force generation are. The individual driving conditions also depend on the type of PZT-material used.

Unipolar amplifiers

PIEZOMECHANIK offers power amplifiers LE and RCV for use with unipolar devices .

No depoling of the PZT-ceramic occurs at elevated temperatures.

Semi-bipolar amplifiers

PZT ceramic accept counter-voltages of about 20 % of the maximum voltage rating ($(-0.2 U_{\max})$) at room-temperature.

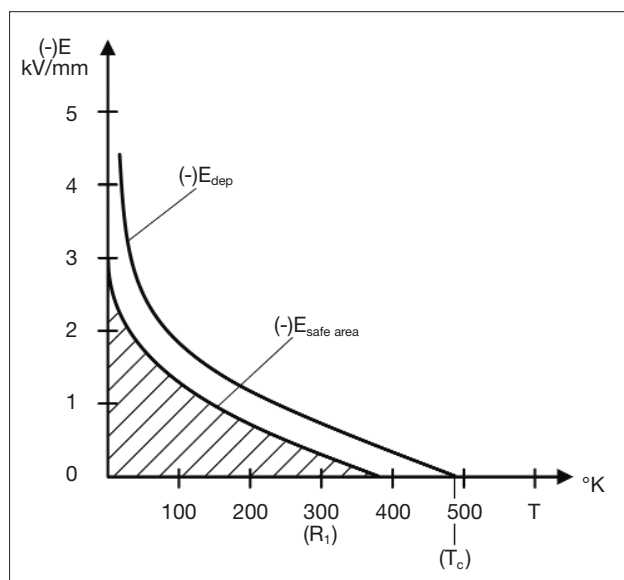

Fig. 9.1: Schematic of the temperature dependence of PZT-ceramics de-poling or coercive field. Counter-field operation of a piezo-actuator must stay in the safe-area at lower electrical field levels compared to E_{depol}

Due to this extended voltage range, an actuator's piezo-mechanical performance like stroke and force generation is increased by at least 20%.

PIEZOMECHANIK offers low power amplifiers SVR for use with semi-bipolar devices, because of the low power level, no self-heating occurs within the piezoceramic.

Bipolar amplifiers

Bipolar ceramic activation at room temperature is mostly done with shear elements or bimorph benders to get symmetrical dual-sided action. Do not exceed the voltage ratings because of the de-poling effect.

PZT-ceramics' stability against field-induced de-poling increases remarkably at cryogenic temperatures. Therefore, piezo stacks accept bipolar operation with maximum voltage ratings at very low temperatures (below 77°K).

PIEZOMECHANIK offers low power bipolar amplifiers SVRbip as standard.



9.2 Alternatives: charge versus voltage control

Analyzing the capacitor-description of the actuator response leads to the following simple relationships. Actuator position $I(t)$ is related to voltage or charge content:

$$\begin{aligned} \text{actuator position} \quad I(t) &\sim Q(t) = C U(t) \\ \text{actuator velocity} \quad v &= dI/dt \sim dQ/dt = I_m \\ \text{actuator acceleration} \quad b &\sim dI_m/dt = \dot{I}_m \end{aligned}$$

$Q(t)$ electrical charge content

Increased dynamic stiffness

The electrical charge balance of a piezo stack is not only changed via the electrical power supply, but also by load force variations (\Rightarrow chap. 4.6). Voltage control dissipates this mechanically generated charge to cancel out unwanted voltage variations. But thereby the mechanical stiffness of the actuator is lowered.

Current control handles quantitatively the charge flow between amplifier and actuator. Mechanically generated charge is not dissipated and results in an increased stiffness of the actuator. Current control is only applicable to dynamic motion.

The relations for charge-and current-control operation of piezo-actuators are only valid for sub-resonant activation.

Due to the non-linear behavior of PZT-ceramics, the control of a piezo-actuator by voltage or charge/current control results in a different response. A current controlling amplifier, via the input signal, primarily modulates an actuator's velocity and not the position.

Linear relation between position and charge content Q

The position-charge-characteristic shows a (near) absence of hysteresis and good linearity fig. 9.2.

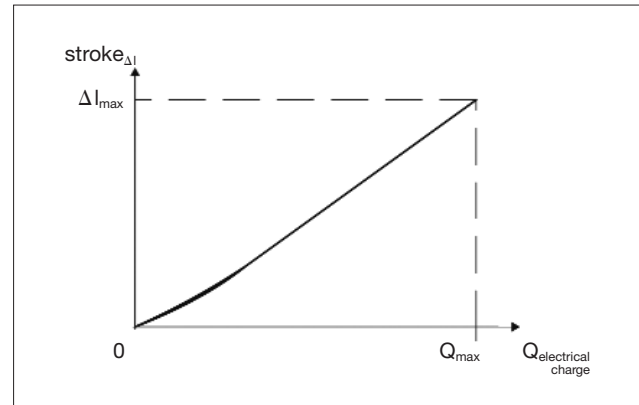

Fig. 9.2: Linear response of position by charge control (max. charge content of actuator at max. driving voltage)



9.2 Alternatives: charge versus voltage control

Conclusions for practice

- Open-loop current control is preferentially used for dynamic motion control or generation of acoustic vibration. The linear open-loop response avoids frequency side-bands (low harmonic distortion).
- Motion control is often aiming to control the dynamic parameters velocity and acceleration. Current control gives direct access to these parameters.
- Higher dynamic stiffness increases the response speed of piezo-mechanical setups.
- Open-loop control of the above parameters is faster than that of closed-loop voltage-control based systems

Charge/current control and precision positioning?

Open-loop charge or current control is not suited for very high accuracy positioning.

Reasons are:

- linearity and hysteresis are limited to about 1% of the maximum stroke
- the charge/position-characteristic varies with temperature
- Low dynamic positioning results in extremely small currents, which are difficult to control. Under static conditions, the self-discharge of a stack by leakage currents cannot be discriminated from position related effects.
- External misaligning effects cannot be compensated for by open-loop control means.

For high accuracy positioning a closed-loop feedback control via position sensing is needed. This will allow the use of simpler and less costly voltage-controlling electronics.

Comments on data sheet

Carefully check the experimental basis for the definition of the actuator's capacitances stated in data sheet. Usually, the so-called low field values are stated in data sheet, measured with very low voltage excitation levels, where the non-linear effects of PZT are not present (capacitance-meters use 1–2 Volts excitation @ 1 kHz).

The high field excitation of PZT ceramics at an actuator's voltage limit shows an effective capacitance larger by 50% or even more compared to the low-field excitation. In addition, capacitance increases further with temperature-rise.

Real actuator capacitances maybe as large as twice the data sheet value.



9.3 Basic piezo amplifier functions



Fig. 9.3:
Front panel of a piezo power amplifier from LE product line

1 Offset

potentiometer for manual setting of a DC-voltage level to piezo. The amplifier can be used as an autonomous power supply with a manual piezo-voltage setting.

In addition, the DC-voltage level will be superimposed to the amplified external signal from input (3)

2 Ampl

potentiometer for continuous variation of amplifier's gain factor for amplifying the external signal (input (3))

3 Input

putting in an analogue signal from an external source (function generator etc.)

4 Monitor

low power signal output parallel to piezo voltage power output (6).

For on-line real time monitoring the piezo-voltage dynamics e.g. via an oscilloscope.
Reduction factor 1:100 or 1:1000.

5 LC-Display

slow response: used for near static read out e.g. together with a manual piezo voltage setting via "Offset"

6 Output plug

supply voltage for the piezo-actuator

Caution:
High voltage, high currents



Guideline:

The main pre-requisite for selecting suitable piezo components is the precise definition of the needed operation profile by the user!

Any supplier of piezo-mechanical components will highly appreciate precise specifications of the requested components beyond “the system shall do as much as possible”.

Putting concrete numbers on the needed piezo-parameters is helpful to avoid over-sizing and mismatch. Poorly selected system components are ineffective and therefore expensive (=> chap. 4).

Please try to analyze the needs for operating your mechanics successfully according to the following:

- A, what shift/stroke shall be achieved?
- B, what force variation shall be generated by the piezo action?
- C, what static preload is acting on the actuator from the beginning?
- D, what is the desired maximum operation frequency?
- E, what is the desired stroke at maximum frequency (D)?
- F, what is the desired max. frequency at maximum stroke (see A)?
- G, shortest achievable rise-/fall-time?
- H, what external masses shall be attached to the actuator?

A, to C, allow an actuator selection for low dynamic operation according chapter 4.

D, to H, aims for the best match for the designated dynamic operation.

Selecting the amplifier

The above selection process results in a piezo-actuator of distinct voltage range and electrical capacitance. Only amplifiers with a matched voltage range should be considered for use.

Do not use amplifiers providing higher voltage!

The dynamic operation profile D, to H, defines the needed current levels (I_{peak} and I_{average}) according chapter 9.1.

When the power consumption of the actuator exceeds the Watt-range, self-heating of the piezo-ceramics can occur (=> chap. 6.1: heat management).

Beyond positioning

The very first application of stack-based piezo-actuation was in (coherent) optics in the 1960's to 1970's as super-precise positioning drives for the emerging laser technology and semi-conductor industry. The other highlights like force generation and high dynamic operation were not a focus, although this has changed over time. Currently, many new applications are aiming to use the whole spectrum of excellent features offered by piezo-actuation.

These new applications include:

- Piezo fuel injectors
- Motion control
- Vibration generation: acoustical, structural excitation
- Hydraulic pumps
- Miniature machines (MEMS, NEMS) etc.

11.1 Piezo action for material testing

Vibration generation by piezo

Component testing for reliability studies or material characterization require well-defined stroke-/force-generation profiles over a large number of cycles. A high level of reproducibility is needed.

Common mechanical drives are then limited in their repetition rates resulting in rather long test periods. For distinct test procedures, piezo-actuators provide a remarkable advantage due to their ability to cycle high frequency together with high reproducibility.

One interesting aspect is the upgrade of conventional test frames by adding a high frequency piezo-drive. The conventional long stroke performance can be superimposed by a high frequency fine modulation (fig.11.1).

Piezo-mechanical arrangements have been successfully used for

- Fretting tests
- Super high cycle fatigue test
- Material testing of polymers
- High frequency vibration excitation, shaker

The frequency range of conventional electro-magnetic shakers is usually limited to about 5 kHz. Piezo-based shakers extend this upper frequency limit towards $\gg 10$ kHz.

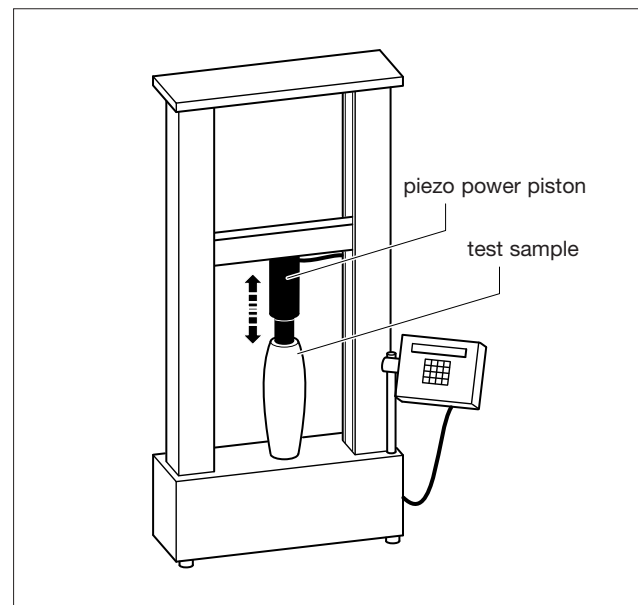

Fig. 11.1: Schematic of conventional set-up for test engineering with added high-load, long stroke piezo-actuator for extended operating dynamics.

100 kHz excitation by small-scale elements is not unusual to excite vibrations in miniature structures for mode-analysis or studies on structural borne acoustics.



11.1 Piezo action for material testing

Shock-generation by piezo

An alternative to high frequency harmonic excitation of structures is the application of single pulses to excite the natural frequencies of a mechanical structure. By analyzing the decay of the excited oscillation, the mechanical parameters of the system can be analyzed.

Piezo-specific unique features are

- non-ballistic shock generation, mechanical contact between shock-partners prior to shock generation and transfer
- wide tuning range of acceleration levels (100 m/sec² up to > 100,000 m/sec²)
- electrical tuning of mechanical shock parameters (e.g. amplitudes, rise-time)
- single shot, bursts or continuous operations are feasible

A kind of intermediate piezo-exciter between shaker and shock-generator would be a burst-generator. A potential application is the simulation of SRS (Shock Response Spectrum) of pyro-shock-tests.

From a technical point of view, shock generation is an unusual driving mode of piezo stacks: the electrical excitation is very short (< 10 µsec) compared to the acoustic transit time of sound through the stack.

The propagating shock-front within the piezoceramic leads to a highly inhomogeneous mechanical stress distribution, both in time and place. This condition is usually strictly avoided in piezo-technology. Special mechanical provisions for the shock-generator design are needed to get a reliable configuration.

Notice:

Piezo shocks shall be distinguished from common "fast acting" piezo-elements as used in fuel-injectors: The electrical excitation time is sufficiently long (about 100µsec) compared to the transit time of sound. The stack is mechanically excited below its natural frequency, having a near homogeneous stress distribution. A real shock actuation within a fuel injector would result in a worsening of the injection balance due to ringing effects.

Calibration, quality control of accelerometers

PIEZOMECHANIK has supplied piezo-shocker based test arrangements to industrial accelerometer manufacturers since 2006.

The basic configurations of suitable arrangements have been published by PIEZOMECHANIK in 2006 including the description of the non-ballistic Hopkinson-bar excitation (=> fig. 11.2).

Material testing with high strain rates can be carried out with higher repetition rates in so-called split Hopkinson-Bar arrangements.

Piezo-shock-generation is now in practical use at calibration services.

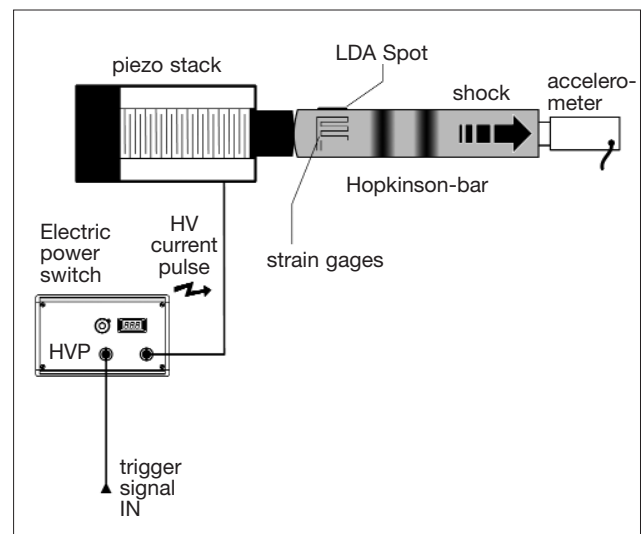

Fig. 11.2: Hopkinson-Bar arrangement for sensor-testing by non-ballistic piezo-shock-generation.



11.2 Motion control

Motion control is a general expression for all kinds of motion generation according distinct defined criteria, usually done in a feed-back controlled system.

A special field in this context is active vibration control with:

- Active vibration generation
- Active vibration cancellation
- Active vibration isolation

Adaptronics, morphing

Piezo-mechanical components are used for dynamic active shaping of functional profiles like adaptive wings, adaptive rotors, adaptive optics, adaptive frame structures.



11.3 Electrical energy generation

The following applications of piezo-elements are not part of PIEZOMECHANIK's program. Disregarding this obvious fact, a lot of inquiries are coming in looking for:

- force transducers, accelerometers
- energy harvesting (energy scavenging)
- piezo transformers

Therefore a few statements shall be made to discriminate between piezo-fantasy and piezo-reality.

The original piezo-electric effect is a generator effect converting a mechanical force input into an electrical charge.

It is also true that this electro-mechanical conversion is bi-directional:

Piezo-mechanics and piezo-electricity

Piezo-actuators exhibit the piezo-electric generator-effect, while they are not specially adapted to this kind of use.

Nevertheless a few hints shall be given:

- the conversion efficiency is related to the g-constants shown in the PZT-material data tables
- PZT ceramics shows to some extent "ageing", meaning a long-term reduction of the conversion efficiency due to de-poling. This is important for the generator effect, but is not relevant for actuation.

- **Force transducers etc.**

For quantitative measurements single crystalline materials are used like quartz. For high temperature application the more effective GaPO_4 is used.

Polycrystalline PZT is a low cost alternative, when a compromise in measurement quality is acceptable. The main advantage of PZT is the much higher generator-efficiency that makes signal detection easier. Usually, force measurements are done by determining the quantity of generated electrical charge, not the induced voltages.

- **Energy harvesting, energy scavenging**

One cubic-centimeter (cm^3) of PZT-material delivers a few milliWattseconds (10^{-3} Ws) energy per cycle even under high mechanical loading. From this fact, it is easily seen that gluing a few piezo-elements into the countryside and squeezing them from time to time will not solve the world's energy problems.

Serious projects dealing with piezo-based generators are talking about "micro-energy-harvesting". Electrical power-generation by piezo depends mainly on cycling frequency. To achieve the order of Watts, cycling frequencies in at least the kilohertz-range are needed.

Applications are autonomously operated arrangements with very small power consumption e.g. for information transfer, sensor units for environmental parameters and toys.



11.3 Electrical energy generation

● Piezo transformers

A perfect example of the bi-directional piezo-effect is a piezo-transformer.

The energy coupling between input and output is done by mechanical coupling avoiding e.g. magnetic fields from inductive elements.

Fig. 11.3 shows a demo-arrangement, based on piezo stack's d_{33} effect.

Two stacks are mounted into a rigid frame.

Stack 1 shows a common multilayer design with a small layer-thickness "d" for low voltage actuation. The second "stack" consists only of one thick layer "D".

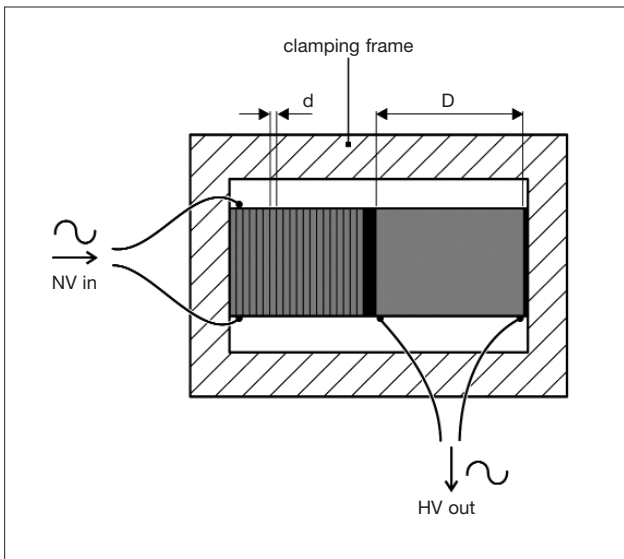

Fig. 11.3: schematic of an axial d_{33} transformer arrangement

Resonant transformers need some care for optimum operation:

The input signal frequency needs to be matched exactly to transformer's resonance. Any power extraction from the transformer is a kind of damping, leading to a detuning of the resonance

Expansion of stack 1 by a low voltage signal input squeezes stack 2 and generates a distinct electrical charge. The big "D" converts it into a high voltage output. This scheme works non-resonantly from cycle to cycle. The cycle frequency determines the average power generation.

Notice: the transformer ratio U_{in}/U_{out} is more complicated than the d/D ratio suggests!

Piezo-transformers in practice:

In practice, resonating systems are used. This inertia-based operation avoids the mounting into a mechanical framework. Efficient resonant operation requires hard ultrasound PZT-ceramics with a high quality factor (\Rightarrow chap. 8).

Typical piezo-transformers use resonances in the range of $\gg 20$ kHz up to Megahertz. Power transfers are typically in the Watt-range. This demonstrates again, that power generation by piezo is mainly a matter of frequency.

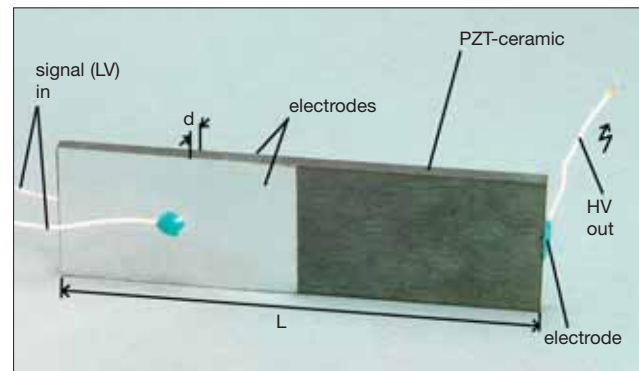

Fig. 11.4: Monolithic high voltage piezo transformer (Rosen-type) for voltage > 10 kV

Mechanical d_{33} - d_{31} coupling. Low voltage signal input via d , high voltage generation by the resonating L

frequency. Some kind of compensation circuitry is needed to get stable power efficiency.

The main advantage of piezo-transformers is their slim design and the absence of magnetic fields. E.g. they are used within laptop-computers for igniting the background illumination of the LCD screen.

Low voltage co-fired multilayer stacks, rings and chips for actuation

Low voltage actuators with coatings, high voltage actuators, Stack-high-voltage

Piezomechanik GmbH

Piezomechanik GmbH

Piezo-mechanical and electrostrictive Stack and ring actuators; Product range and Technical data

Piezomechanik GmbH

Low voltage Highly Dynamic Piezo Actuators

PSt-HD 200
 for Rapid valve switching
 Adaptive structures
 High temperature actuation
 and others

Piezomechanik GmbH

Piezoelectric Optomechanics
 Piezo Mirror-shifters
 Piezoelectric Translation Stages

Piezomechanik GmbH

Electronic Supplies for Piezomechanics
 Amplifiers
 Pulsers
 PC cards

Piezomechanik GmbH

Power Electronics
 PiezoCon.am
 for piezoelectric actuators
 low voltage and high voltage actuators

Piezomechanik GmbH

Piezo Vibrations and Piezo Shakers

Generating

- High Forces
- High Acceleration Rates
- High Frequencies

within the audio and ultrasonic range

Piezomechanik GmbH

Piezo Impactors/Accelerators (PIA) for Shock and Impact Generation

Generation of mechanical pulses with μ sec rise-times and μ sec timing accuracy

- Acceleration rates up to >10000 g
- Variable repetition rates
- High forces

High power piezoelectric axial shockwave generation

Hr. Schulz, HLT AG, Schwan FL
 L. Pickelmann, Piezomechanik GmbH, München

Piezomechanik · Dr. Lutz Pickelmann GmbH

Berg-am-Laim-Straße 64 · D-81673 München · Telefon ++ 49/89/4 31 55 83 · Fax ++ 49/89/4 31 64 12
 E-Mail: info@piezomechanik.com · http://www.piezomechanik.com

