

Light Emitting Diodes with central wavelength 2,35 μm series are based on heterostructures grown on GaSb substrates by LPE. Solid solutions GaInAsSb are used in the active layer. Wide band gap solid solutions AlGaAsSb with Al content 64% are used for good electron confinement.

Parameters	Units	Conditions	Ratings		
			Min	Typ	Max
Peak emission wavelength	μm	T=300 K	2,33	2,35	2,39
FWHM of the emission band	nm	150 mA CW	170	220	270
Quasi-CW Optical Power	mW	200 mA qCW	0,6	0,8	1
Pulsed Optical Power	mW	1 A	12	15	20
Switching Time	ns	T=300 K	10	20	30
Operating Temperature Range, $^{\circ}\text{C}$	-240 $^{\circ}$ \div +50 $^{\circ}$				
Emitting Area, μm	300x300				
Soldering temperature	260 $^{\circ}\text{C}$				
Package					
SMD type package 3x3 mm based on high thermal conductivity ceramics			MID IR LED-SMD3		
SMD type package 5x5 mm based on high thermal conductivity ceramics			MID IR LED-SMD5		
SMD type package 5x5 mm based on high thermal conductivity ceramics with microreflector			MID IR LED-SMD5R		

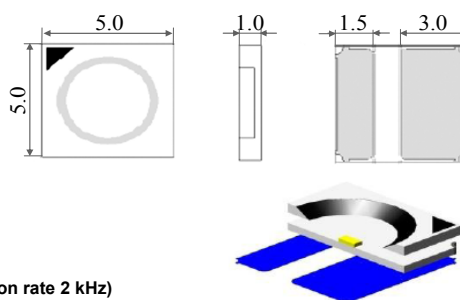

Maximum current is 220 mA at quasi-CW
Maximum pulsed current is 1 A (duration 500 ns, repetition rate 2 kHz)
Optimal operating current is 150-200 mA at quasi-CW.

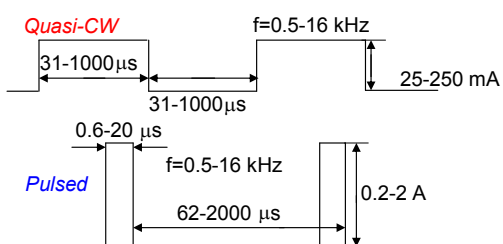
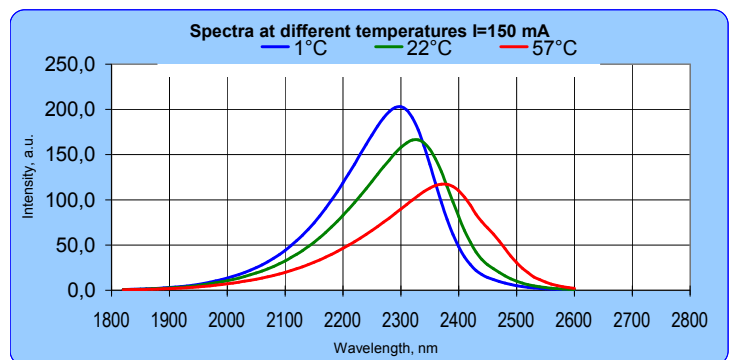
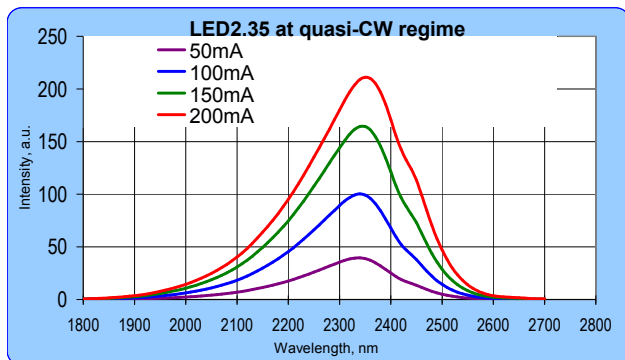