

Ndrive Linear Series

Digital Servo Amplifiers – Linear

Output power range of 10 or 20 A peak with ± 10 to ± 80 VDC bus

2- or 3-phase AC line input or DC input

CE approval

Linear power stages

Digital current, velocity, and position loops for improved motion stability

Optional integrated encoder multiplier for higher throughput and reduced wiring

Flexible design provides ability to drive brushless and DC brush-type servomotors as well as stepping motors

Encoder or resolver feedback



Ndrive HLe

Ndrive CL

Ndrive ML

The Ndrive® family of digital servo amplifiers are high performance discrete drives used with the Automation 3200 motion controller. These drives are capable of controlling brushless, DC brush, and stepper motors over a wide range of operating voltages and currents. Based on a common architecture, Ndrive amplifiers perform both current- and position-loop closures digitally.

The use of high-performance double-precision processors allows these drives to generate ultra-smooth motion profiles. Servo system response is optimized with the use of up to eight second-order loop-shaping filters, precise time-aligned feed-forward and other proprietary techniques with loop closure rates up to 20 kHz.

The Ndrive family includes several versions of low noise, ultra-high-performance linear drives. The Ndrive series provides high bandwidth and superb linearity required for the ultimate in velocity regulation as well as positional stability. The HLe offers the ability to use resolver or

inductosyn sensors and provides the highest level of encoder interpolation. The Ndrive CL is available for applications requiring low noise and is optimized for cost sensitive, lower-power applications. For low-power, high precision systems use the Ndrive ML.

Options for the Ndrive family include integral encoder interpolation, one- to three-axis position synchronized output (PSO), automatic brake control, digital and analog I/O expansion, absolute encoder interface, and one- or two-channel resolver interfaces. An optional dedicated ethernet port is available on the HLe drives for connection to third-party I/O expansion devices. This provides the potential to connect to a large number of I/O points typically required for PLC-type applications.

Any combination of Ndrive amplifiers may be connected to the Automation 3200 FireWire® network, allowing the system to be customized as needed.

Ndrive Series COMPARISON



Ndrive HLe
Width: 206.9 mm
Height: 234.3 mm



Ndrive CL
Width: 103.7 mm
Height: 265.2 mm



Ndrive ML
Width: 92.1 mm
Height: 141.0 mm

Ndrive Comparison Chart	Ndrive HLe	Ndrive CL	Ndrive ML
PC Interface	FireWire®	FireWire®	FireWire®
Current Output, Peak ⁽¹⁾	10-20 A ⁽²⁾	10 A ⁽²⁾	10 A ⁽²⁾
Current Output, Continuous ⁽¹⁾	5-10 A ⁽²⁾	5 A ⁽²⁾	5 A ⁽²⁾
Bus Voltage	±40-80 VDC ⁽³⁾	±40 VDC ⁽³⁾	±40 VDC ⁽³⁾
Amplifier Type	Linear	Linear	Linear
Motor Supply Voltage	2 Phase AC	2 Phase AC ⁽⁴⁾	DC
Standard I/O ⁽⁵⁾	4-DO/6-DI 1-AO/1-AI	4-DO/6-DI 1-AO/1-AI	1-AI
Expansion I/O ⁽⁵⁾ (Additional to Base I/O)	16-DO/16-DI 3-AO/3-AI	16-DO/16-DI 1-AO/1-AI	8-DO/8-DI 1-AO/1-AI
Single Axis PSO ⁽⁶⁾	Yes	Yes	Yes
Dual Axis PSO ⁽⁶⁾	Yes	No	No
Triple Axis PSO ⁽⁶⁾	Yes	No	No
Ethernet Capable for Third-Party I/O	Yes	No	No

Notes:

1. Peak value of the sine wave; rms current for AC motors is $0.707 * A_{pk}$.
2. Load dependent.
3. Output voltage is load dependent.
4. External transformer required.
5. DO = Digital Output; DI = Digital Input; AO = Analog Output; AI = Analog Input.
6. PSO not available on Ndrive CL/ML when using integral MXU.

Ndrive HLe SPECIFICATIONS

Ndrive HLe	Units	10-40	20-40	10-80
Motor Style		Brush, Brushless, Stepper, Voice Coil		
Motor Supply	VAC	115/230; 50/60 Hz; Factory Configured		
Control Supply ⁽¹⁾	VAC	85-240; 50/60 Hz		
Bus Voltage ⁽²⁾	VDC	±40	±40	±80
Peak Output Current (1 sec) ^(3,4)	A _{pk}	10	20	10
Continuous Output Current ^(3,4)	A _{pk}	5	10	5
Digital Inputs	—	6 Optically-Isolated (2 High Speed)		
Digital Outputs	—	4 Optically-Isolated		
Analog Inputs	—	One 16-bit Differential; ±10 V		
Analog Outputs	—	One 16-bit Single-Ended		
Dedicated Axis I/O on Feedback Connector		Three Limit Inputs (CW, CCW, Home); Three Hall Effect Inputs (A, B, C); Three High-Speed differential Inputs (sin, cos, mkr for encoder); Motor Over-Temperature Input		
Dedicated I/O on Auxiliary Feedback Connector		sin, cos, mkr for Aux Enc; Aux Enc can be used for PSO Output		
I/O Expansion Board ⁽⁵⁾	—	16/16 Digital Opto-Isolated; 3 Analog In (±10 V, 16-bit Differential); 3 Analog Out (±10 V, 16-bit)		
High Speed Data Capture		Yes (50 ns Latency)		
Automatic Brake Control	—	Standard; 24 V @ 1 A		
Emergency Stop Sense Input (ESTOP) ⁽⁶⁾	—	Standard; 24 V Opto-Isolated		
Position Synchronized Output (PSO)	—	Single Axis Standard, Two/Three Axis Optional		
Can Output Multiplied Encoder		Yes		
Can Output Square Wave Encoder		Yes		
Primary Encoder Input Frequency		32 MHz Square Wave Standard; 500 kHz Sine Wave (MXH)		
Secondary Encoder Input Frequency		32 MHz Square Wave		
Encoder Multiplication	—	Up to x65536 with Quadrature Output (MXH)		
Absolute Encoder		Renishaw Resolute BiSS; EnDat 2.1; EnDat 2.2		
Resolver Interface	—	Optional; 1 or 2 Channel; 16-bit		
Internal Shunt Resistor		N/A		
External Shunt		N/A		
Ethernet	—	Optional		
USB		No		
RS-232		No		
FireWire		Yes		
Fieldbus		Modbus TCP on PC		
Current Loop Update Rate	kHz	20		
Servo Loop Update Rate	kHz	8		
Power Amplifier Bandwidth	kHz	Selectable Through Software		
Minimum Load Inductance	mH	0		
Operating Temperature	°C	0 to 50		
Storage Temperature	°C	-30 to 85		
Weight	kg (lb)	10.36 (22.8)		

Notes:

1. "Keep Alive" supply.
2. Output voltage is load dependent.
3. Peak value of the sine wave; rms current for AC motors is $0.707 * A_{pk}$.
4. Load dependent.
5. Requires IO option.
6. Requires external relay to remove motor supply power.

Ndrive CL SPECIFICATIONS

Ndrive CL	Units	
Motor Style		Brush, Brushless, Stepper, Voice Coil
Motor Supply	VAC	56 (center tapped transformer; two 28 VAC windings); Max
Control Supply ⁽¹⁾	VAC	85-240; 50/60 Hz
Bus Voltage ⁽²⁾	VDC	±40
Peak Output Current (1 sec) ^(3,4)	A _{pk}	10
Continuous Output Current ^(3,4)	A _{pk}	5
Digital Inputs	—	6 Optically-Isolated (2 High Speed)
Digital Outputs	—	4 Optically-Isolated
Analog Inputs	—	One 16-bit Differential; ±10 V
Analog Outputs	—	One 16-bit Single-Ended
Dedicated Axis I/O on Feedback Connector		Three Limit Inputs (CW, CCW, Home); Three Hall Effect Inputs (A, B, C); Three High-Speed differential Inputs (sin, cos, mkr for encoder); Motor Over-Temperature Input
Dedicated I/O on Auxiliary Feedback Connector		sin, cos, mkr for Aux Enc; Aux Enc can be used for PSO Output
I/O Expansion Board ⁽⁵⁾	—	16/16 Digital Opto-Isolated; 1 Analog In (±10 V, 12-bit Differential); 1 Analog Out (±10 V, 12-bit)
High Speed Data Capture		Yes (50 ns Latency)
Automatic Brake Control	—	Optional
Emergency Stop Sense Input (ESTOP) ⁽⁶⁾	—	Standard; 24 V Opto-Isolated
Position Synchronized Output (PSO)	—	Single Axis Only
Can Output Multiplied Encoder		No
Can Output Square Wave Encoder		Yes
Primary Encoder Input Frequency		32 MHz Square Wave Standard; 400 kHz Sine Wave (MXU)
Secondary Encoder Input Frequency		32 MHz Square Wave
Encoder Multiplication	—	Up to x8192 (MXU)
Resolver Interface	—	N/A
Internal Shunt Resistor		N/A
External Shunt		N/A
Ethernet	—	N/A
USB		No
RS-232		No
FireWire		Yes
Fieldbus		Modbus TCP on PC
Current Loop Update Rate	kHz	20
Servo Loop Update Rate	kHz	8
Power Amplifier Bandwidth	kHz	Selectable Through Software
Minimum Load Inductance	mH	0
Operating Temperature	°C	0 to 50
Storage Temperature	°C	-30 to 85
Weight	kg (lb)	3.54 (7.8)

Notes:

- "Keep Alive" supply.
- Output voltage is load dependent.
- Peak value of the sine wave; rms current for AC motors is $0.707 \cdot A_{pk}$.
- Load dependent.
- Requires IO option.
- Requires external relay to remove motor supply power.

Ndrive ML SPECIFICATIONS

Ndrive ML	Units	
Motor Style		Brush, Brushless, Stepper, Voice Coil
Motor Supply	VDC	±40 max
Control Supply ⁽¹⁾	VDC	18-36 VDC
Bus Voltage ⁽²⁾	VDC	±40
Peak Output Current (1 sec) ^(3,4)	A _{pk}	10
Continuous Output Current ^(3,4)	A _{pk}	5
Digital Inputs	—	N/A
Digital Outputs	—	N/A
Analog Inputs	—	One 16-bit Differential; ±10 V
Analog Outputs	—	N/A
Dedicated Axis I/O on Feedback Connector		Three Limit Inputs (CW, CCW, Home); Three Hall Effect Inputs (A, B, C); Three High-Speed differential Inputs (sin, cos, mkr for encoder); Motor Over-Temperature Input
Dedicated I/O on Auxiliary Feedback Connector		N/A
I/O Expansion Board ⁽⁵⁾	—	8/8 Digital Opto-Isolated; 1 Analog In (±10 V, 16-bit Differential); 1 Analog Out (±5 V, 16-bit); sin, cos, mkr for Aux Enc; Aux Enc can be used for PSO Output
High Speed Data Capture		Yes (50 ns Latency)
Automatic Brake Control	—	Optional
Emergency Stop Sense Input (ESTOP) ⁽⁶⁾	—	Standard; 24 V Opto-Isolated
Position Synchronized Output	—	Single Axis Only
Can Output Multiplied Encoder		Yes (MXH Only)
Can Output Square Wave Encoder		Yes
Primary Encoder Input Frequency		32 MHz Square Wave Standard; 2 MHz Sine Wave (MXU or MXH)
Secondary Encoder Input Frequency		32 MHz Square Wave
Encoder Multiplication	—	Up to x4096 (MXU); Up to x65536 with Quadrature Output (MXH)
Resolver Interface	—	N/A
Internal Shunt Resistor		N/A
External Shunt		N/A
Ethernet	—	N/A
USB		No
RS-232		No
FireWire		Yes
Fieldbus		Modbus TCP on PC
Current Loop Update Rate	kHz	20
Servo Loop Update Rate	kHz	8
Power Amplifier Bandwidth	kHz	Selectable Through Software
Minimum Load Inductance	mH	0
Operating Temperature	°C	0 to 50
Storage Temperature	°C	-30 to 85
Weight	kg	1.0

Notes:

1. "Keep Alive" supply.
2. Output voltage is load dependent.
3. Peak value of the sine wave; rms current for AC motors is $0.707 * A_{pk}$.
4. Load dependent.
5. Requires IO option.
6. Requires external relay to remove motor supply power.

Ndrive HLe DIMENSIONS

Ndrive HLe with Optional I/O

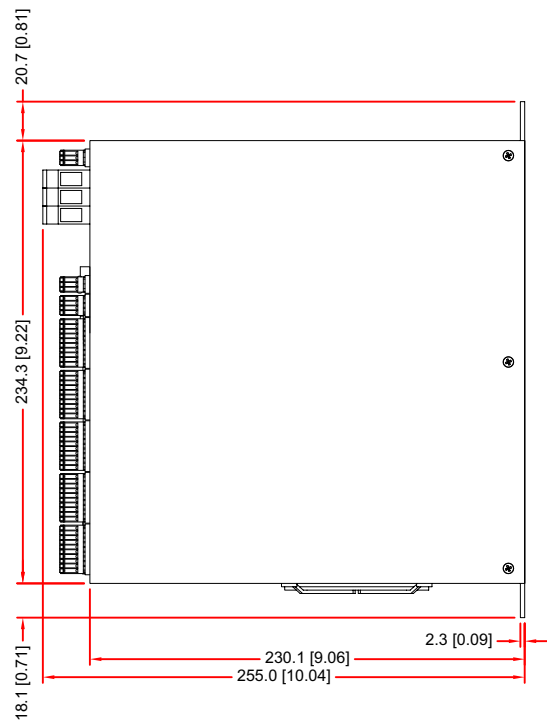
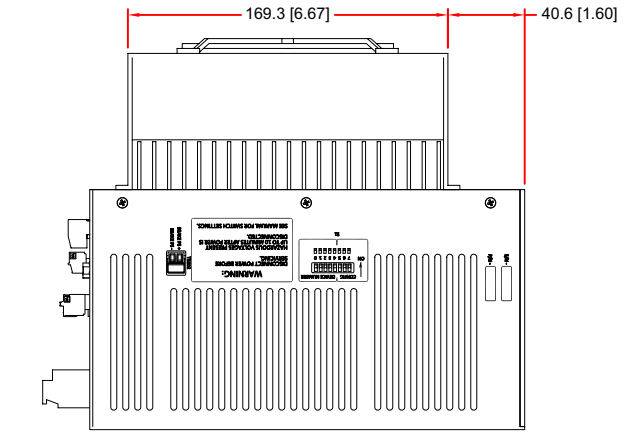
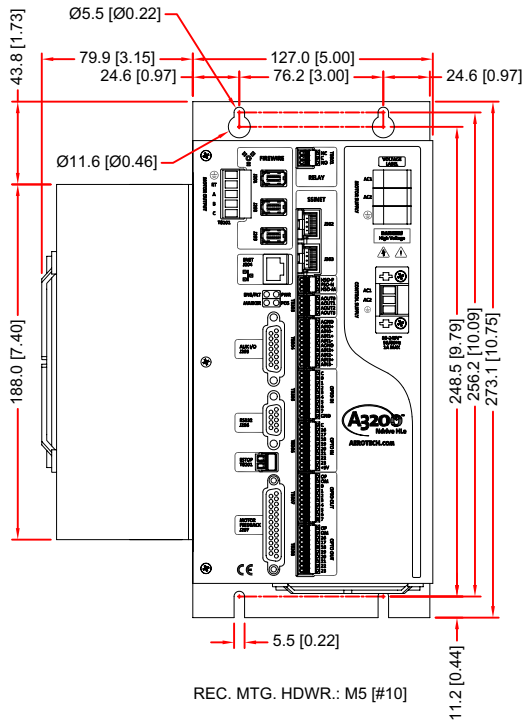

Ndrive HLe DIMENSIONS

Ndrive HLe with Optional I/O and Resolver

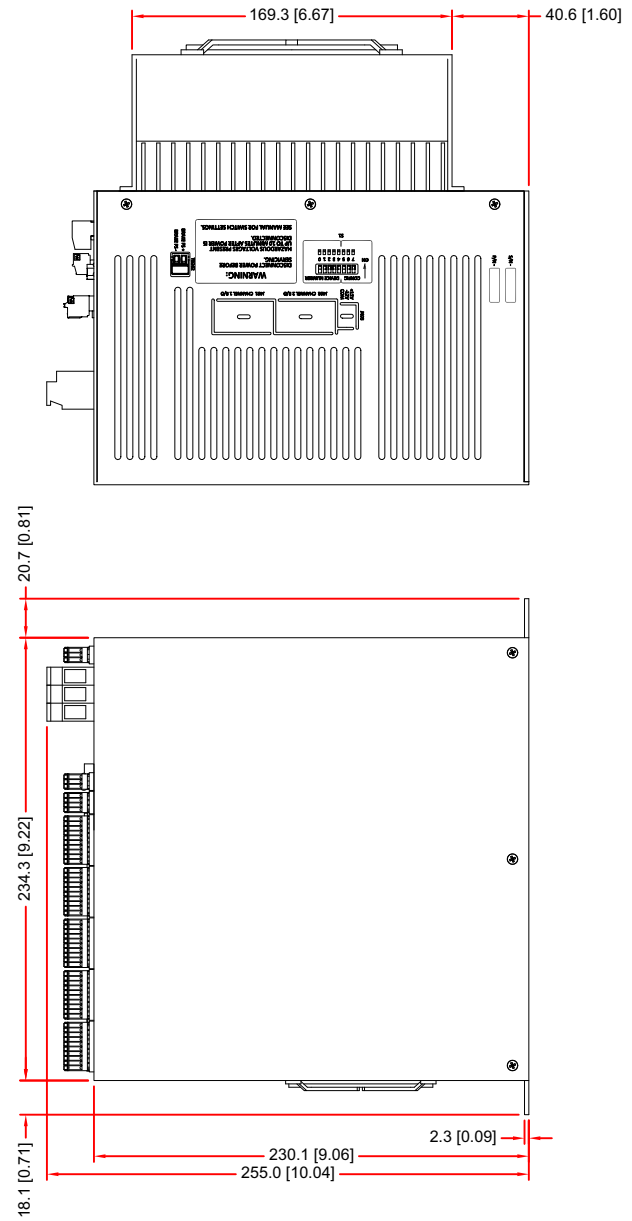
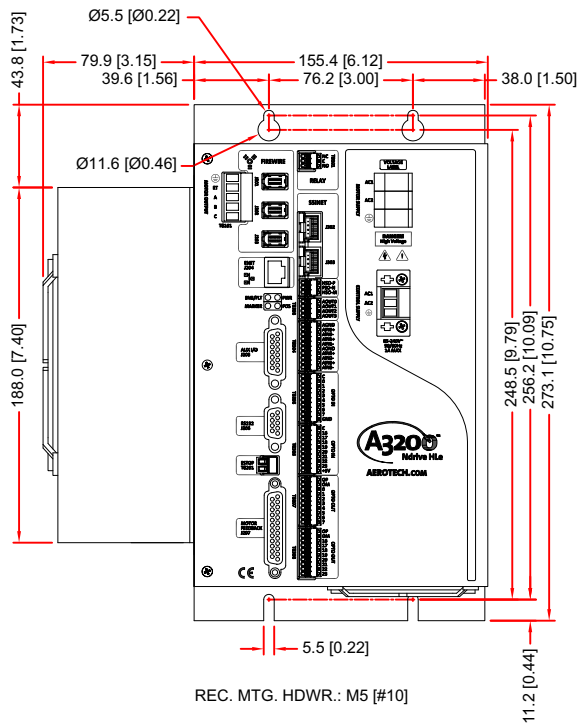

Ndrive CL with Optional I/O
 (Dimensions without optional I/O are identical)

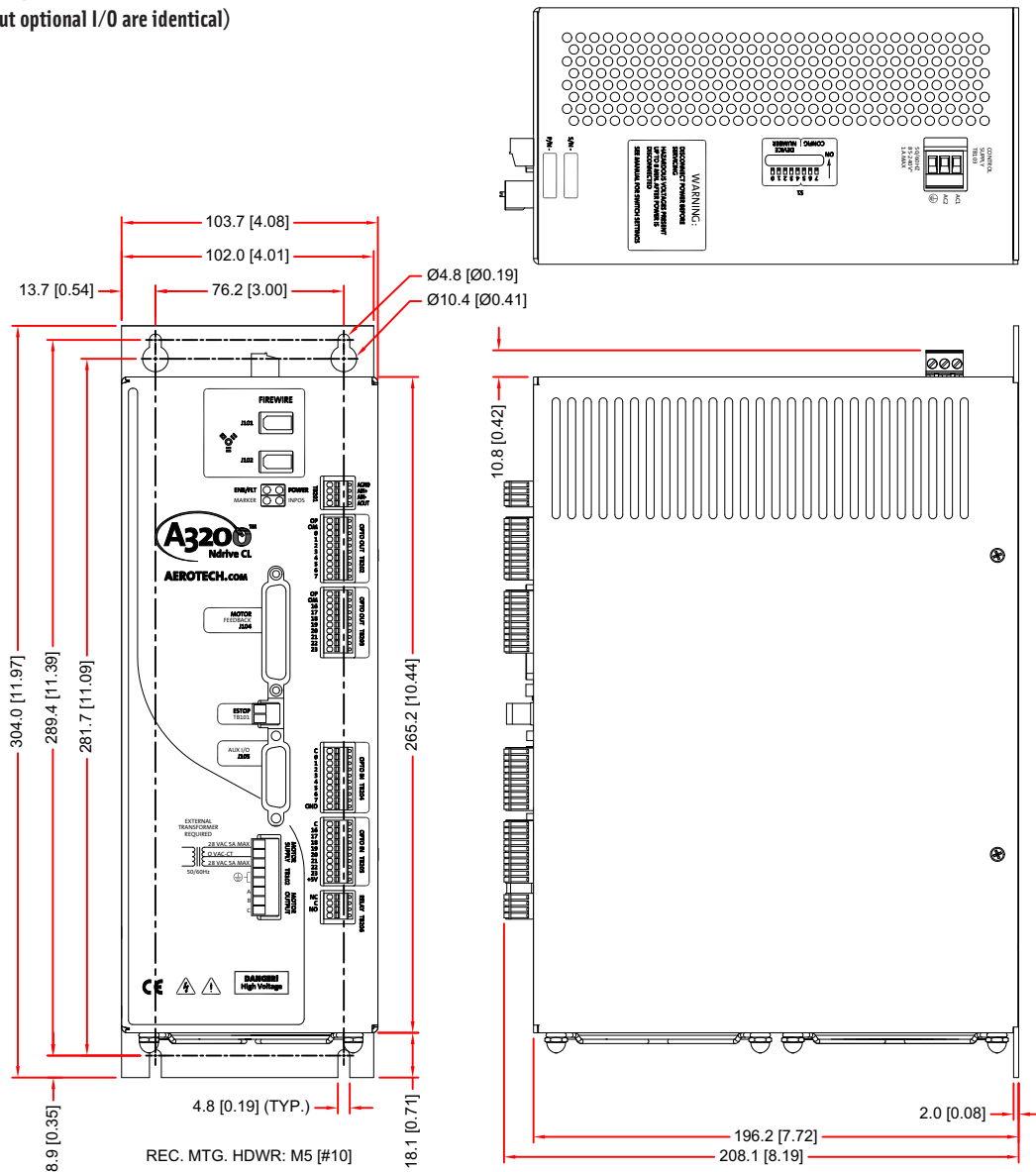

Ndrive ML DIMENSIONS

Ndrive ML with Optional I/O

(Dimensions without optional I/O are identical)

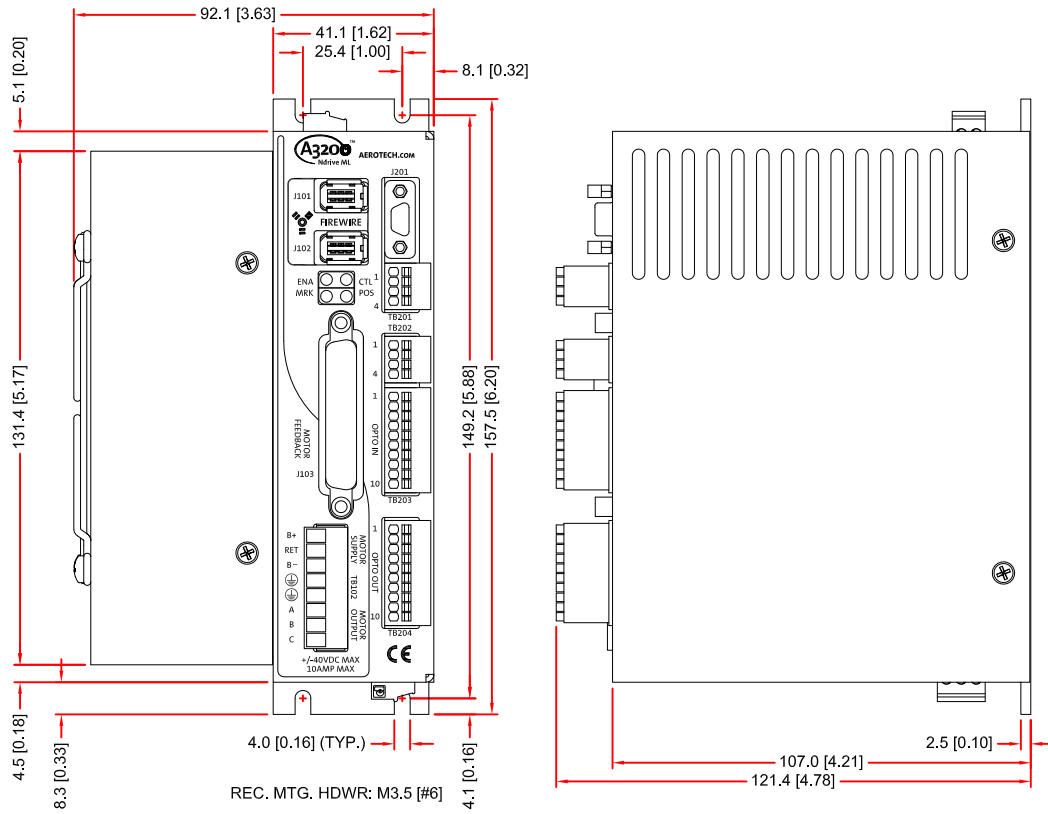

Ndrive Series ORDERING INFORMATION

Ordering Example

Ndrive HLe	20-40-X	-ENET	RDP1-10K
Base	Output Current	Control Option	Resolver Options
Ndrive HLe	10-40-X 20-40-X 10-80-X	-IO -DUALPSO -TRIPLEPSO -PSOPTO2 -PSOPTO3 -PSOPTO4 -PSOAH -MXH -ENET	RDP1-10K RDP1-7.5K RDP1-5K RDP2-10K RDP2-7.5K RDP2-5K
Ndrive CL	10-40	-IO -MXU	
Ndrive ML	10-40	-IO -MXU -MXH	

NDRIVE HLe (Linear)

NDRIVE HLe10-40-x	10 A peak/5 A continuous (load dependent), ± 40 VDC bus, 115/230 VAC control supply input to power logic circuitry; supports brushless, brush, and stepper motors; includes: 4 opto-isolated digital inputs (sinking or sourcing), 2 high-speed digital inputs, 4 opto-isolated digital outputs (sinking or sourcing), 1 16-bit analog output, 1 16-bit differential analog input, single-axis PSO capability, 2 quadrature encoder input channels, ESTOP sense input
NDRIVE HLe20-40-x	20 A peak/10 A continuous (load dependent), ± 40 VDC bus, 115/230 VAC control supply input to power logic circuitry; supports brushless, brush, and stepper motors; includes: 4 opto-isolated digital inputs (sinking or sourcing), 2 high-speed digital inputs, 4 opto-isolated digital outputs (sinking or sourcing), 1 16-bit analog output, 1 16-bit differential analog input, single-axis PSO capability, 2 quadrature encoder input channels, ESTOP sense input
NDRIVE HLe10-80-x	10 A peak/5 A continuous (load dependent), ± 80 VDC bus, 115/230 VAC control supply input to power logic circuitry; supports brushless, brush, and stepper motors; includes: 4 opto-isolated digital inputs (sinking or sourcing), 2 high-speed digital inputs, 4 opto-isolated digital outputs (sinking or sourcing), 1 16-bit analog output, 1 16-bit differential analog input, single-axis PSO capability, 2 quadrature encoder input channels, ESTOP sense input

NDRIVE HLe Line Voltage (-x) Options

-A	115 VAC input
-B	230 VAC input
-C	100 VAC input
-D	200/208 VAC input

NDRIVE HLe Control Options

-I/O	Expansion board with 16 opto-isolated inputs (sinking or sourcing); 16 outputs (sinking or sourcing); 3 16-bit analog inputs; 3 16-bit analog outputs; brake relay
-DUALPSO	Two-axis PSO firing; second encoder input through AUX connection on Ndrive or through SSINET on I/O board, includes HCPL2601 opto-isolator
-TRIPLEPSO	Three-axis PSO firing; requires I/O option to provide connections for three axes of encoder feedback; includes HCPL2601 opto-isolator
-PSOPTO2	Opto-isolator for PSO; requires IOx option (<+15 V, high speed, low current, 6N136)
-PSOPTO3	Opto-isolator for PSO; requires IOx option (<+30 V, low speed, high current, 4N33)
-PSOPTO4	Opto-isolator for PSO; requires IOx option (TIL117-M, 40 kHz, 5-25 VDC, 50 mA)
-PSOAH	Active-high PSO output
-MXH	Programmable encoder multiplier up to x65536 with real-time encoder quadrature output
-ENET	10/100 BASE-T Ethernet port

Ndrive Series ORDERING INFORMATION**NDRIVE HLe Resolver Options**

RDP1-10K	Ndrive 1-channel resolver to digital feedback card with dynamic resolution switching capability; 10 kHz carrier frequency
RDP1-7.5K	Ndrive 1-channel resolver to digital feedback card with dynamic resolution switching capability; 7.5 kHz carrier frequency
RDP1-5K	Ndrive 1-channel resolver to digital feedback card with dynamic resolution switching capability; 5 kHz carrier frequency
RDP2-10K	Ndrive 2-channel resolver to digital feedback card with dynamic resolution switching capability; 10 kHz carrier frequency
RDP2-7.5K	Ndrive 2-channel resolver to digital feedback card with dynamic resolution switching capability; 7.5 kHz carrier frequency
RDP2-5K	Ndrive 2-channel resolver to digital feedback card with dynamic resolution switching capability; 5 kHz carrier frequency

NDRIVE CL

NDRIVE CL10-40	10 A peak/5 A continuous (load dependent), ± 40 VDC bus, 85-240 VAC control supply input to power logic circuitry; supports brush and brushless motors; includes: 4 opto-isolated digital outputs (sinking or sourcing); 6 opto-isolated digital inputs (sinking or sourcing); 1 16-bit analog output; 1 16-bit differential analog input; single-axis PSO capability; 2 quadrature encoder input channels; ESTOP sense input
----------------	---

NDRIVE CL Control Options

-I/O	Expansion board with 16 opto-isolated inputs (sinking or sourcing); 16 outputs (sinking or sourcing); 1 12-bit analog input; 1 16-bit analog output; brake relay
-MXU	Programmable encoder multiplier up to x8192; no real-time encoder quadrature output

NDRIVE ML

NDRIVE ML10	10 A peak/5 A continuous (load dependent), ± 40 VDC bus, 18-36 VDC control supply input to power logic circuitry; supports brush and brushless motors; includes: 1 16-bit differential analog input; single-axis PSO capability; 1 quadrature encoder input channel; ESTOP sense input
-------------	--

NDRIVE ML Control Options

-I/O	Expansion board with 8 opto-isolated inputs (sinking or sourcing); 8 outputs (sinking or sourcing); 1 16-bit analog input; 1 16-bit analog output; brake relay
-MXU	Programmable encoder multiplier up to x4096; no real-time encoder quadrature output
-MXH	Programmable encoder multiplier up to x65536 with real-time encoder quadrature output