

ANT130-V Series

Single-Axis Lift Direct-Drive

Nanopositioning Stage

Nanometer performance with
5 mm vertical travel

High resolution (2 nm), repeatability (100 nm),
and accuracy (200 nm)

In-position stability of <2 nm

Anti-creep crossed-roller bearings

High dynamic performance

nano Motion Technology



Introduction

Aerotech's ANT series stages are the world's first nanometer-level positioning systems with multi-millimeter travel. The ANT130-V and ANT130-V-PLUS are linear-motor-driven wedge-style vertical lift stages. The stages are designed to be seamlessly integrated with other stages in the ANT130 family for superior multi-axis performance, and are offered in two accuracy grades.

Noncontact Direct-Drive Design

All of the original ANT series' direct-drive advantages have been preserved in the ANT130-V family. Only noncontact direct-drive technology offers the robust, accurate, and high-speed positioning necessary for mass production of precision devices. ANT130-V stages utilize advanced direct-drive technology pioneered by Aerotech to achieve the highest level of positioning performance. This direct-drive technology is high-performance, non-cogging, noncontact, high-speed, high-resolution, and high-accuracy. This unique drive and bearing combination, packaged in an extremely small-profile and footprint, offers tangible advantages in many applications such as high-precision positioning, disk-drive fabrication, fiber alignment, optical delay element actuation, sensor testing, and scanning processes that demand smooth and precise motion.

Flexible System Design

The ANT130-V family has universal mounting and tabletop patterns that allow for easy system integration. Two, three, or more axes can be combined easily for flexible system designs and multi-axis configurations.

System Characteristics

Outstanding accuracy, position repeatability, and in-position stability require high system resolution. The ANT130-V stage's industry-leading 2 nm minimum incremental step size provides this high level of performance. Excellent in-position stability is assisted by high-quality, anti-creep, crossed-roller bearings. The stage offers virtually maintenance-free operation over the life of the product. Aerotech's direct-drive technology has no hysteresis or backlash, enabling accurate and repeatable nanometer-scale motion.

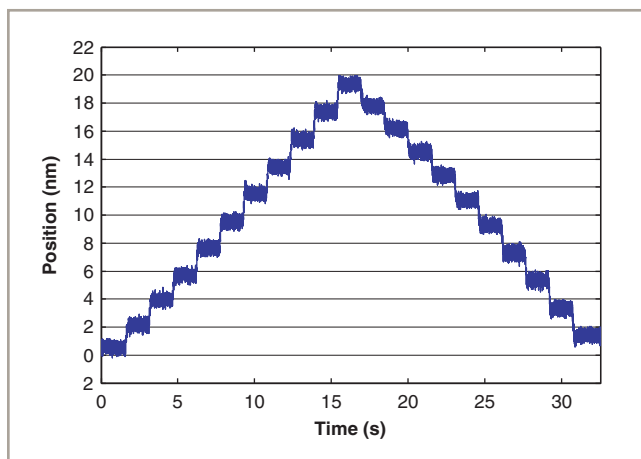

ANT130-5-V-PLUS 2 nm step plot. Best-in-class resolution and exceptional in-position stability for large travel stages.

ANT130-V/ANT130-V-PLUS Series SPECIFICATIONS

Mechanical Specifications	ANT130-5-V	ANT130-5-V-PLUS
Travel	5 mm	
Accuracy ⁽¹⁾	±2 μm (± 80 μin)	±200 nm (± 8 μin)
Resolution	2 nm (± 0.08 μin)	
Repeatability (Bi-Directional) ⁽¹⁾	±150 nm (± 6 μin)	±100 nm (± 4 μin)
Repeatability (Uni-Directional)	±75 nm (± 3 μin)	
Straightness ⁽²⁾	±1.0 μm (±40 μin)	
Pitch ⁽¹⁾	20 arc sec	
Roll	10 arc sec	
Yaw ⁽¹⁾	10 arc sec	
Maximum Speed	75 mm/s (3 in/s)	
Maximum Acceleration	0.7 g - 7 m/s ² (No Load)	
Settling Time	See graphs for typical performance	
In-Position Stability ⁽³⁾	<2 nm (<0.08 μin)	
Maximum Force (Continuous)	100 N	
Load Capacity ⁽⁴⁾	3.0 kg (6.6 lb)	
Moving Mass	1.8 kg (4 lb)	
Stage Mass	3.1 kg (7 lb)	
Material	Aluminum Body/Black Hardcoat Finish/Black Anodize Finish	
MTBF (Mean Time Between Failure)	30,000 Hours	

Notes:

1. Certified with each stage.
 2. Measured perpendicular or parallel to wedge direction.
 3. In-Position Stability listing is 3 sigma value.
 4. Assumes loading along axis of travel.
- Specifications are per axis, measured 25 mm above the tabletop. Performance of multi-axis systems is payload and workpoint dependent. Consult factory for multi-axis or non-standard applications.
 - -PLUS requires the use of an Aerotech controller

Electrical Specifications	ANT130-5-V
Drive System	Brushless Linear Servomotor
Feedback	Noncontact Linear Encoder
Maximum Bus Voltage	±40 VDC
Limit Switches	5 V, Normally Closed
Home Switch	Near Center

Recommended Controller	ANT130-5-V
Multi-Axis	A3200 Npaq-MXR Npaq MR-MXH Ndrive ML-MXH
	Ensemble Epaq-MXH Epaq MR-MXH Ensemble ML-MXH
Single Axis	Soloist Soloist ML-MXH

Notes:

1. Linear amplifiers are required to achieve the listed specifications. Other options are available.

Note: To ensure the achievement and repeatability of specifications over an extended period of time, environmental temperature must be controlled to within 0.25°C/24 hours. If this is not possible, alternate products are available. Please consult Aerotech Application Engineering for more information.

ANT130-V/ANT130-V-PLUS Series PERFORMANCE

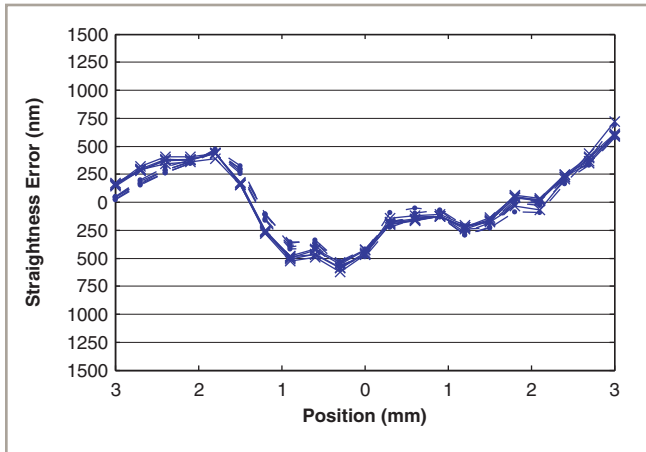

ANT130-5-V-PLUS straightness error, five runs, bi-directional, parallel to the wedge.

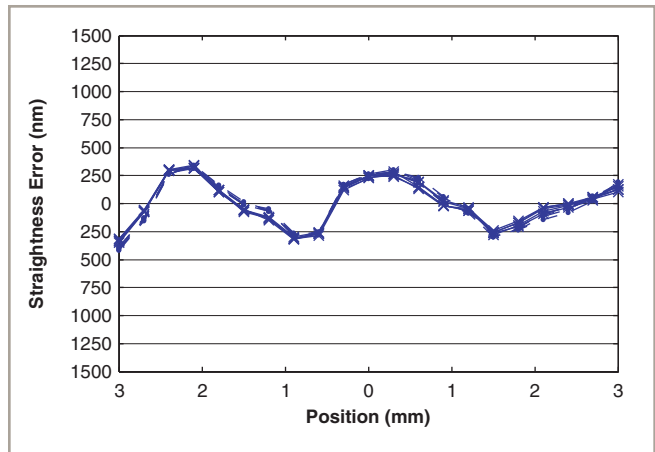

ANT130-5-V-PLUS straightness error, five runs, bi-directional, perpendicular to the wedge.

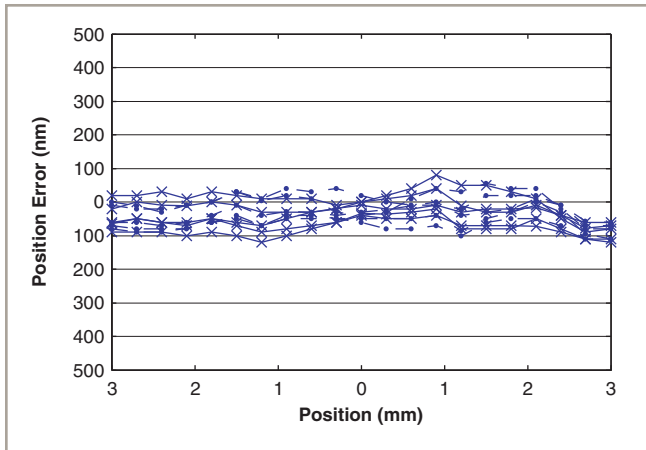

ANT130-5-V-PLUS accuracy and repeatability. This multiple test run over an extended period of time shows the high level of system accuracy and repeatability.

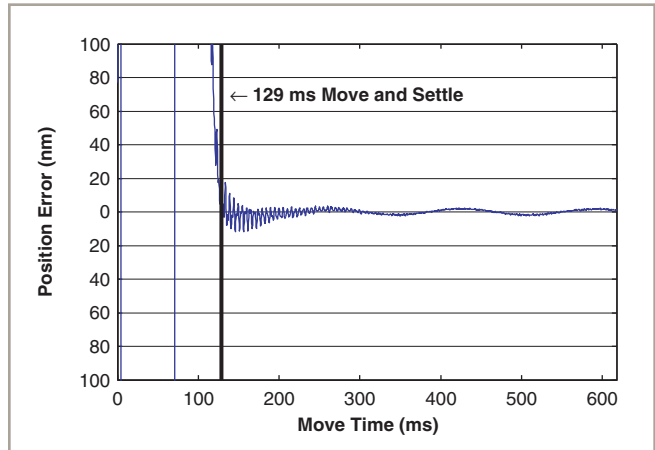

ANT130-5-V-PLUS step and settle performance at 75 mm/s, with a settle spec of ± 20 nm, and a step size of 5 mm. Outstanding settling time enhances throughput of most applications.

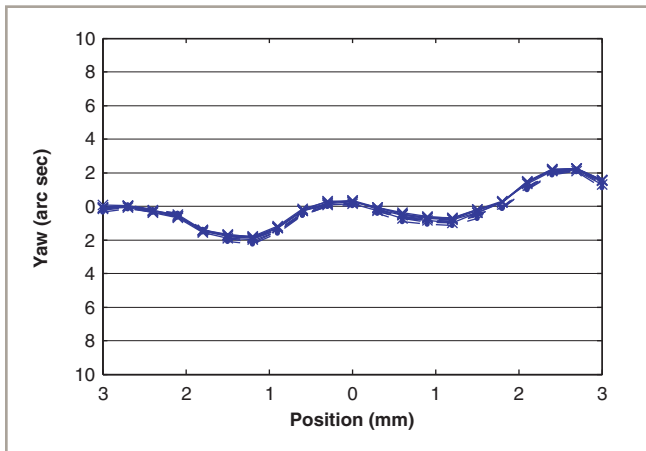

ANT130-5-V-PLUS yaw, five runs, bi-directional. Highly repeatable, minimal yaw error enhances system positioning accuracy.

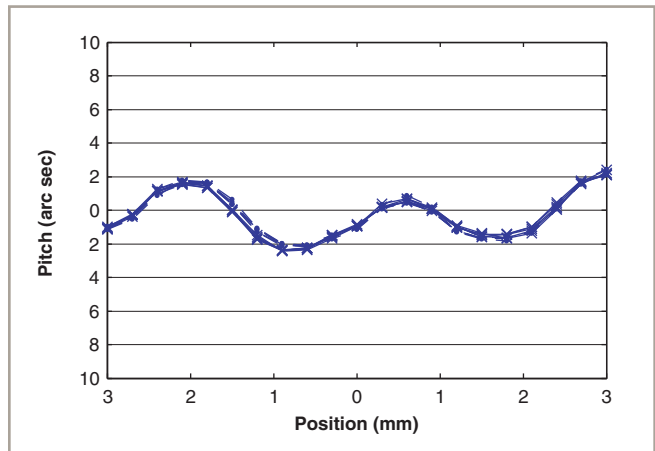

ANT130-5-V-PLUS pitch, five runs, bi-directional. Excellent repeatability/accuracy contribute to improved processing.

ANT130-5-V/ANT130-5-V-PLUS DIMENSIONS

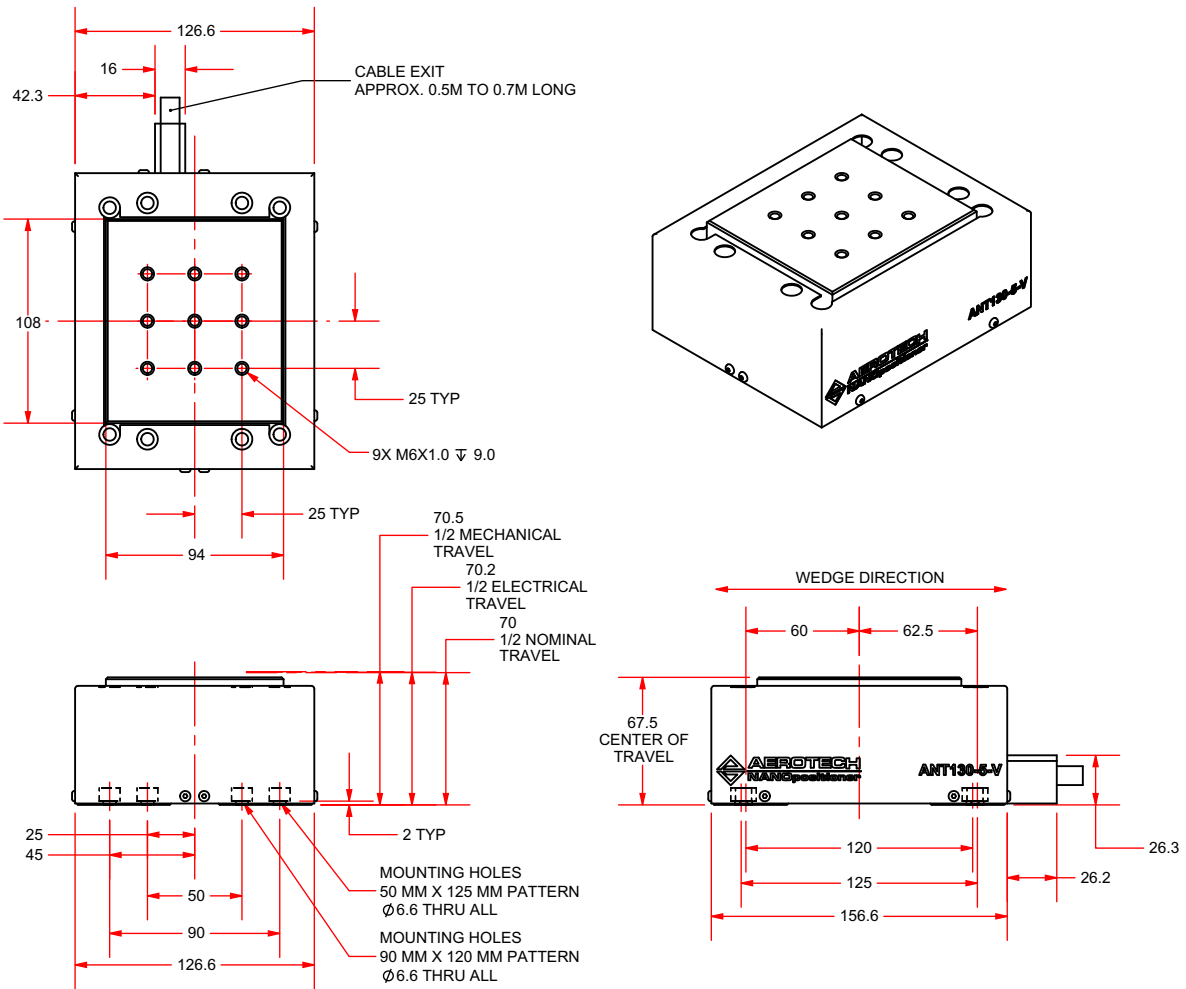

ANT130-5-V/ANT130-5-V-PLUS Mounting Plate DIMENSIONS

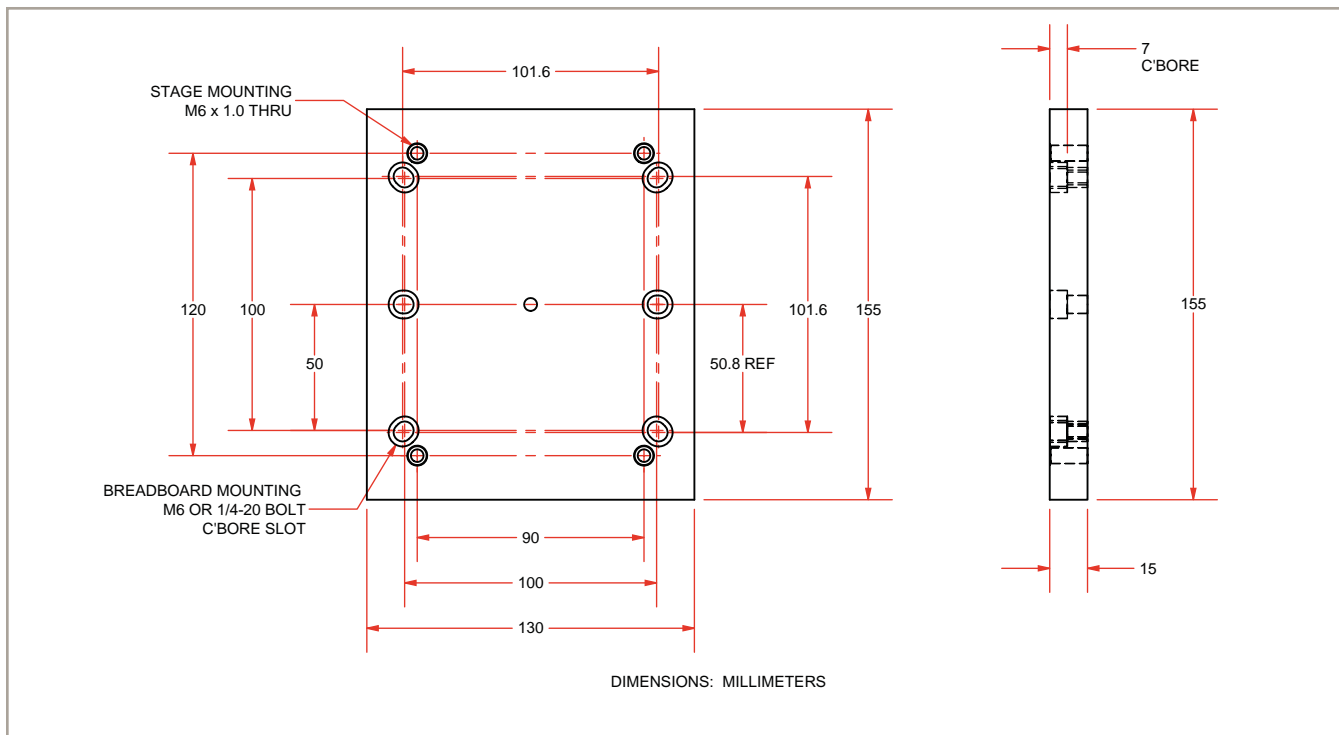

ANT130-V/ANT130-V-PLUS Series ORDERING INFORMATION

ANT130-V Series Lift Stage

ANT130-V/ANT130-V-PLUS Aerotech nanotranslation crossed-roller bearing vertical lift positioner

Linear Stage Travel

ANT130-5-V	5 mm vertical travel lift stage with proprietary direct-drive motor technology, 1 V _{p-p} sinusoidal output linear encoder and limits
ANT130-5-V-PLUS	5 mm vertical travel lift stage with proprietary direct-drive motor technology, 1 V _{p-p} sinusoidal output linear encoder and limits (High Accuracy Version)

Output Cable Connectors

-25DU	Single 25-pin D connector (standard)
-4DU-25DU	4-pin HPD and 25-pin D connectors

Note: -25DU single 25-pin connector option not valid for systems using bus voltages greater than 80 V

Options

-MP	Breadboard mounting plate
-----	---------------------------